



Installation and operating instructions Hand-held instrument PI 500



Foreword

I. Foreword

Dear customer,

thank you very much for deciding in favour of the PI 500. Please read this installation and operation manual carefully before mounting and initiating the device and follow our advice. A riskless operation and a correct functioning of the PI 500 are only guaranteed in case of careful observation of the described instructions and notes.



Sales Office South / Geschäftsstelle Süd

Zindelsteiner Str. 15

D-78052 VS-Tannheim

Tel.: +49 (0) 7705 978 99 0

Fax: +49 (0) 7705 978 99 20

Mail: info@cs-instruments.com

Web: <http://www.cs-instruments.com>

Sales Office North / Geschäftsstelle Nord

Am Oxer 28c

D-24955 Harrislee

Tel.: +49 (0) 461 700 20 25

Fax: +49 (0) 461 700 20 26

Mail: info@cs-instruments.com

Web: <http://www.cs-instruments.com>

Table of Contents

II. Table of Contents

II. TABLE OF CONTENTS	3
1 SAFETY INSTRUCTIONS	6
2 APPLICATION AREA	7
3 TECHNICAL DATA PI 500	8
4 INPUT SIGNALS EXT. SENSOR PI 500	9
5 CABLE CROSS SECTION	9
5.1 Sensor circuit points/Output signal:	9
6 CONNECTION DIAGRAMS OF THE DIFFERENT SENSOR TYPES	10
6.1 Connector pin assignment for all sensors at PI 500	10
6.2 Connection CS dew point sensors series FA 415/FA 300	11
6.3 Connection for CS dew point- and consumption sensors, series FA/VA 400	11
6.4 Connection for CS dew point- and consumption sensors, series FA/VA 5xx	11
6.5 Connection pulse sensors	12
6.6 Analogue two-, three-, and four-wire current signal	13
6.7 Three- and four-wire power supply 0 - 1/10/30 VDC	14
6.8 Two-, three- and four-wire connector pin assignments for PT100/PT1000/KTY81	15
6.9 Connection with RS485	15

Table of Contents

7	OPERATION PI 500	16
7.1	Keypad	16
7.1.1	On- and Off-button	16
7.1.2	Brightness buttons	16
7.1.3	Screenshot-Button	16
7.1.3.1	Storing Screenshot	16
7.1.3.2	Export Screenshots	17
7.2	Touchpanel	19
7.3	Main menu (Home)	20
7.3.1	Initialization	20
7.3.2	Main menu	21
7.3.2.1	Settings	22
7.3.2.1.1	Password-Settings	22
7.3.2.1.2	Sensor-settings	23
7.3.2.1.2.1	Choice of the sensor type (For example type CS-Digital sensor)	24
7.3.2.1.2.2	Name the measurement data and define the decimal places	25
7.3.2.1.2.3	Recording measurement data	25
7.3.2.1.2.4	Alarm-Settings (Alarm Popup)	26
7.3.2.1.2.5	More Settings (scale analogue output)	27
7.3.2.1.2.6	Dew Point Sensor of type CS-Digital (SDI Bus)	28
7.3.2.1.2.7	Consumption Sensor of type CS-Digital (SDI Bus)	29
7.3.2.1.2.8	Dew Point Sensor FA 500 / FA 510 of type FA 5xx (RS 485 Modbus)	32
7.3.2.1.2.8.1	Settings Dew point sensor FA 500 FA 510	33
7.3.2.1.2.9	Flow sensor of type VA 5xx (RS 485 Modbus)	36
7.3.2.1.2.9.1	Settings for Flow sensor VA 5xx	37
7.3.2.1.2.9.2	Diameter settings (only for VA 500 or VA 550)	37
7.3.2.1.2.9.3	Gas Constant settings	38
7.3.2.1.2.9.4	Definition of the reference conditions	39
7.3.2.1.2.9.5	Definition Unit of flow and velocity	39
7.3.2.1.2.9.6	Definition consumption counter value and consumption unit	40
7.3.2.1.2.9.7	Settings analogue output 4-20mA of VA 5xx	41
7.3.2.1.2.9.8	Settings Pulse / Alarm output of VA 5xx	42
7.3.2.1.2.9.9	Settings ZeroPoint or Low Flow Cut off for VA 5xx	43
7.3.2.1.2.10	Configuration of Analogue-Sensors	44
7.3.2.1.2.11	Type 0 - 1/10/30 Volt and 0/4 – 20 mA	44
7.3.2.1.2.12	Type PT100x and KTY81	46
7.3.2.1.2.13	Type Pulse (Pulse ration)	47
7.3.2.1.2.14	Type „No Sensor“	49
7.3.2.1.2.15	Type Modbus	50
7.3.2.1.2.16	Selection and activation of Sensor-Type Modbus	50
7.3.2.1.2.16.1	Modbus Settings	50
7.3.2.1.3	Data logger Settings	54
7.3.2.1.4	Device Settings	58
7.3.2.1.4.1	Language	58
7.3.2.1.4.2	Date & Time	59
7.3.2.1.4.3	SD-Card	60
7.3.2.1.4.4	System update	61
7.3.2.1.4.4.1	Check for new Software updates (USB)	61
7.3.2.1.4.5	Factory Reset	63
7.3.2.1.4.6	Calibrate touch-screen	64

Table of Contents

7.3.2.1.5	Set backlight	64
7.3.2.1.6	Cleaning	65
7.3.2.1.7	System-Status	65
7.3.2.1.8	About PI 500	65
7.3.2.2	Chart	66
7.3.2.3	Chart / Real time values	70
7.3.2.4	Channels	72
7.3.2.4.1	Min/Max Function	72
7.3.2.5	Real time values	74
7.3.2.6	Alarm overview	75
7.3.2.7	Export Data	Fehler! Textmarke nicht definiert.
8	VIRTUAL CHANNELS (OPTIONAL)	80
8.1	Option „Virtual Channels“ activation	80
8.2	Virtual Channels Settings	81
8.2.1	Selection of Sensor-type	81
8.2.2	Configuration of each single virtual value	82
8.2.3	Activation of a single virtual value	82
8.2.4	Definition of Operands	82
8.2.5	Definition of Operations	84
8.2.6	Definition of Unit	84
8.2.7	Value name, resolution of decimal places and recording of values	86
9	ANALOG TOTAL (OPTIONAL)	87
9.1	Option „Analog Total“ activation	87
9.2	Selection of sensor type	88

1 Safety instructions



Please check whether this manual corresponds with the device type.

Please attend to all notes indicated in this instruction manual. It contains essential information that has to be followed during installation, operation and maintenance. Therefore, this instruction manual has to be read categorically by the technician as well as by the responsible user/qualified personnel before installation, initiation and maintenance.

This instruction manual has to be available at any time at the operation site of the PI 500. Regional and national regulations respectively, have to be observed in addition to this instruction manual if necessary.

In case of any obscurities or questions with regard to this manual or the instrument please contact CS Instruments GmbH.



Warning!

Supply voltage!

Contact with supply voltage carrying non-insulated parts may cause an electric shock with injury and death.

Measures:

- Note all applicable regulations for electrical installations (e.g. VDE 0100)!
- **Carry out maintenance only in strain less state!**
- All electric works are only allowed to be carried out by authorized qualified personnel.



Warning!

Inadmissible operating parameters!

Undercutting and exceeding respectively of limit values may cause danger to persons and material and may lead to functional and operational disturbances.

Measures:

- Make sure that the PI 500 is only operated within the admissible limit values indicated on the type label.
- Strict observance of the performance data of the PI 500 in connection with the application.
- Do not exceed the admissible storage and transportation temperature.

Further safety instructions:

- Attention should also be paid to the applicable national regulations and safety instructions during installation and operation.
- The PI 500 is not allowed to be used in explosive areas.

Additional remarks:

- Do not overheat the instrument!
- PI 500 is not allowed to be disassembled!



Attention!

Malfunctions at the PI 500!

Faulty installation and insufficient maintenance may lead to malfunctions of the PI 500 which may affect the measuring results and which may lead to misinterpretations.

2 Application Area

The new PI 500 is an all-purpose hand-held measuring instrument for many applications in industry
Like e.g.:

- ▶ Consumption/flow measurement
- ▶ Pressure/vacuum measurement
- ▶ Temperature measurement
- ▶ Moisture/dew point measurement

The 3.5" graphic display with touch screen makes the operation very easy.

The graphic indication of coloured measurement curves is inimitably.

Up to 100 million measured values can be stored with date and name of measuring site. The measured data can be transferred to the computer via USB stick.

The following sensors can be connected to the freely configurable sensor input of PI 500:

- Pressure sensors (high and low pressure)
- Flow sensors, VA 400/420
- Temperature sensors Pt 100, 4...20 mA
- Dew point sensors FA410 / FA415
- Effective power meters
- Optional third-party sensors with the following signals:
0...1/10 V, 0/4...20 mA, Pt100, Pt1000, pulse, Modbus

3 Technical data PI 500

CE	
Colour screen	3.5"-Touchpanel TFT transmissive, graphics, curves, statistics
Interfaces	USB
Power supply for sensors	Output voltage: 24 VDC \pm 10% Output current: 120 mA continuous operation
Current supply	Internal rechargeable Li-Ion batteries charging time approx. 4 h PI 500 operation: > 4h depending on current consumption of external sensor
Power supply unit	100 – 240 VAC/50 – 60 Hz, 12VDC – 1A Safety class 2, only for application in dry rooms
Dimension	82 x 96 x 245 mm
Material	Plastic PC/ABS
Weight	450 g
Operating temperature	-20...70°C measuring gas temperature 0... 50°C ambient temperature
Storage temperature	-20 to +70°C
Optional	Data Logger, Memory size 2 GB SD memory card standard, optionally up to 4 GB
EMC	DIN EN 61326

4 Input signals ext. sensor PI 500

Input signals		
Current signal (0 – 20 mA / 4 – 20 mA) internal or external power supply	Measuring range	0 – 20 mA / 4 – 20 mA
	Resolution	0,0001 mA
	Accuracy	$\pm 0,03 \text{ mA} \pm 0,05 \%$
	Input resistance	50 Ω
Voltage signal (0 - 1V)	Measuring range	0 - 1 V
	Resolution	0,05 mV
	Accuracy	$\pm 0,2 \text{ mV} \pm 0,05 \%$
	Input resistance	100 k Ω
Voltage signal (0 - 10 V / 30 V)	Measuring range	0 - 10 V/30 V
	Resolution	0,5 mV
	Accuracy	$\pm 2 \text{ mV} \pm 0,05 \%$
	Input resistance	1 M Ω
RTD Pt100	Measuring range	-200 - 850 °C
	Resolution	0,1 °C
	Accuracy	$\pm 0,2 \text{ °C}$ at -100 - 400 °C $\pm 0,3 \text{ °C}$ (further range)
RTD Pt1000	Measuring range	-200 - 850 °C
	Resolution	0,1 °C
	Accuracy	$\pm 0,2 \text{ °C}$ at -100 - 400 °C $\pm 0,3 \text{ °C}$ (further range)
Pulse	Measuring range	minimal pulse length 100 μs frequency 0 - 1 kHz max. 30 VDC

5 Cable cross section

5.1 Sensor circuit points/Output signal:

AWG16 – AWG28, cable cross-sections: 0,14 - 1,5 mm²

Connection diagrams of the different sensor types

6 Connection diagrams of the different sensor types

6.1 Connector pin assignment for all sensors at PI 500

The interface connector to be used is a ODU Medi Snap 8 pin – Reference: K11M07-P08LFD0-6550

Available connection cables at CS-Instruments are:

ODU with Open ends: Order no 0553 0501, cable length: 5 m.
Order no 0553 0502, cable length: 10 m.

ODU with M12 Connector: Order no 0553 0503, cable length: 5 m.

Extension cable (ODU/ODU): Order no 0553 0504, cable length: 10 m.

Connection scheme:

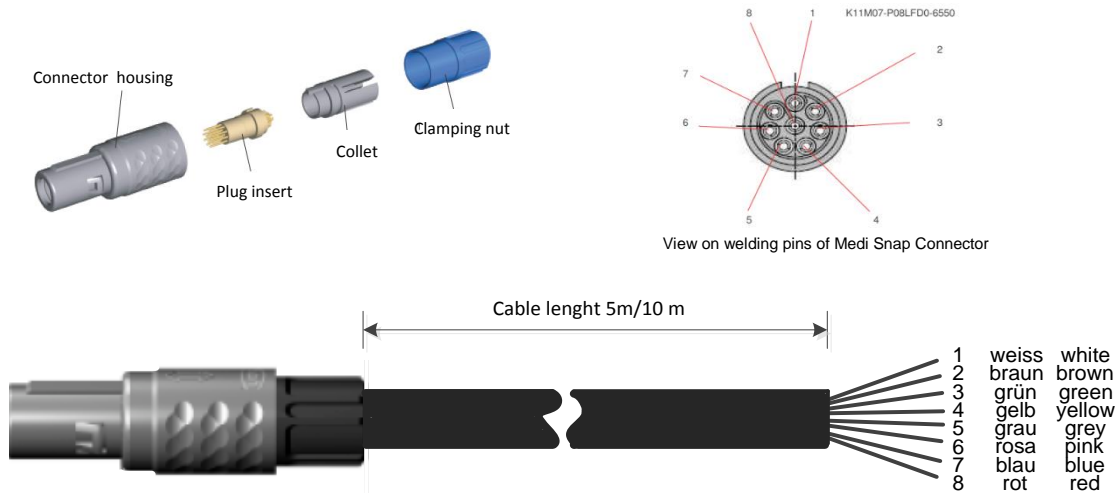

+ RS485 ● 1	White	+ RS485
- RS485 ● 2	Brown	- RS485
SDI ● 3	Green	SDI (CS-internal data transmission for all Dew point and Flow sensor FA/ VA 400)
Analog IN + ● 4	Yellow	ANALOG IN +
Analog IN - ● 5	Grey	ANALOG IN -)
I (500µA) ● 6	Pink	STROMQUELLE 500 µA
+VB 24Vdc ● 7	Blue	+VB, 24V DC Power supply for sensor
-VB GND ● 8	Red	-VB, GND Sensor

Connection diagrams of the different sensor types

FA serial: dew point sensors from CS Instruments

VA serial: consumption sensors from CS Instruments

6.2 Connection CS dew point sensors series FA 415/FA 300

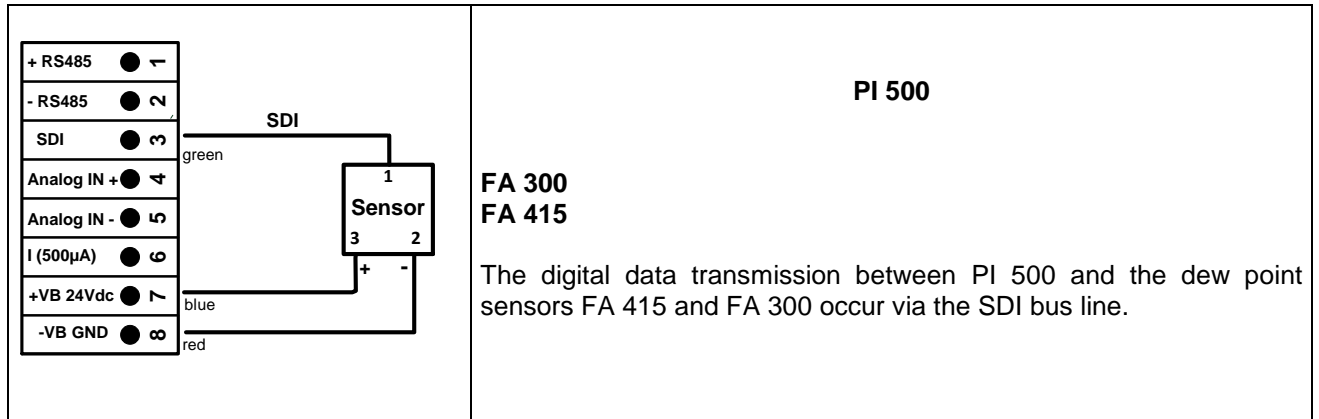

6.3 Connection for CS dew point- and consumption sensors, series FA/VA 400

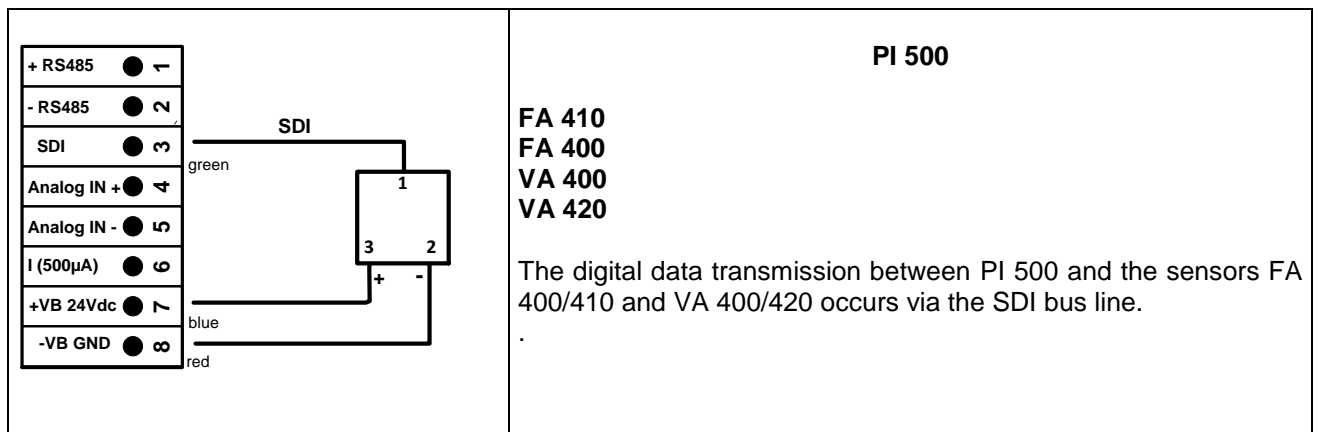

6.4 Connection for CS dew point- and consumption sensors, series FA/VA 5xx

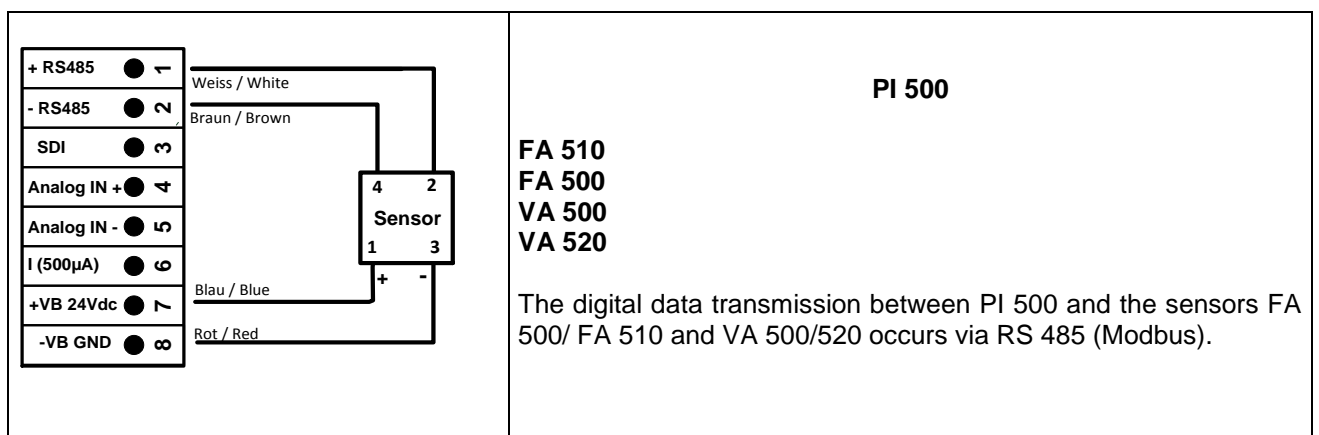

Connection diagrams of the different sensor types

6.5 Connection pulse sensors

		<p>Signal level 0: low = 0 – 0,7 VDC</p> <p>Signal level 1: high = 2,5 – 30 VDC</p> <p>$t = 400 \mu s$</p> <p>max. frequency (duty cycle 1:1) = 1000 Hz</p> <p>input resistance: min. 100 kilo ohm</p>
		<p>Required external $R = 4K7$</p> <p>Attention: The PI 500 is counting a consumption unit, by switching „power on“.</p>
		<p>Required external $R = 4K7$</p>
		<p>Not possible / allowed!</p>

Connection diagrams of the different sensor types

6.6 Analogue two-, three-, and four-wire current signal

Sensors with 4 - 20 mA-output in 2-wire technology																									
<table border="1"> <tr><td>+ RS485</td><td>●</td><td>1</td></tr> <tr><td>- RS485</td><td>●</td><td>2</td></tr> <tr><td>SDI</td><td>●</td><td>3</td></tr> <tr><td>Analog IN +</td><td>●</td><td>4</td></tr> <tr><td>Analog IN -</td><td>●</td><td>5</td></tr> <tr><td>I (500µA)</td><td>●</td><td>6</td></tr> <tr><td>+VB 24Vdc</td><td>●</td><td>7</td></tr> <tr><td>-VB GND</td><td>●</td><td>8</td></tr> </table>	+ RS485	●	1	- RS485	●	2	SDI	●	3	Analog IN +	●	4	Analog IN -	●	5	I (500µA)	●	6	+VB 24Vdc	●	7	-VB GND	●	8	<p>PI 500</p>
+ RS485	●	1																							
- RS485	●	2																							
SDI	●	3																							
Analog IN +	●	4																							
Analog IN -	●	5																							
I (500µA)	●	6																							
+VB 24Vdc	●	7																							
-VB GND	●	8																							
Sensors with 4 - 20 mA output in 3-wire technology																									
<table border="1"> <tr><td>+ RS485</td><td>●</td><td>1</td></tr> <tr><td>- RS485</td><td>●</td><td>2</td></tr> <tr><td>SDI</td><td>●</td><td>3</td></tr> <tr><td>Analog IN +</td><td>●</td><td>4</td></tr> <tr><td>Analog IN -</td><td>●</td><td>5</td></tr> <tr><td>I (500µA)</td><td>●</td><td>6</td></tr> <tr><td>+VB 24Vdc</td><td>●</td><td>7</td></tr> <tr><td>-VB GND</td><td>●</td><td>8</td></tr> </table>	+ RS485	●	1	- RS485	●	2	SDI	●	3	Analog IN +	●	4	Analog IN -	●	5	I (500µA)	●	6	+VB 24Vdc	●	7	-VB GND	●	8	<p>PI 500</p>
+ RS485	●	1																							
- RS485	●	2																							
SDI	●	3																							
Analog IN +	●	4																							
Analog IN -	●	5																							
I (500µA)	●	6																							
+VB 24Vdc	●	7																							
-VB GND	●	8																							
Sensors with 4 - 20 mA output in 4-wire technology																									
<table border="1"> <tr><td>+ RS485</td><td>●</td><td>1</td></tr> <tr><td>- RS485</td><td>●</td><td>2</td></tr> <tr><td>SDI</td><td>●</td><td>3</td></tr> <tr><td>Analog IN +</td><td>●</td><td>4</td></tr> <tr><td>Analog IN -</td><td>●</td><td>5</td></tr> <tr><td>I (500µA)</td><td>●</td><td>6</td></tr> <tr><td>+VB 24Vdc</td><td>●</td><td>7</td></tr> <tr><td>-VB GND</td><td>●</td><td>8</td></tr> </table>	+ RS485	●	1	- RS485	●	2	SDI	●	3	Analog IN +	●	4	Analog IN -	●	5	I (500µA)	●	6	+VB 24Vdc	●	7	-VB GND	●	8	<p>PI 500</p>
+ RS485	●	1																							
- RS485	●	2																							
SDI	●	3																							
Analog IN +	●	4																							
Analog IN -	●	5																							
I (500µA)	●	6																							
+VB 24Vdc	●	7																							
-VB GND	●	8																							

Connection diagrams of the different sensor types

6.7 Three- and four-wire power supply 0 - 1/10/30 VDC

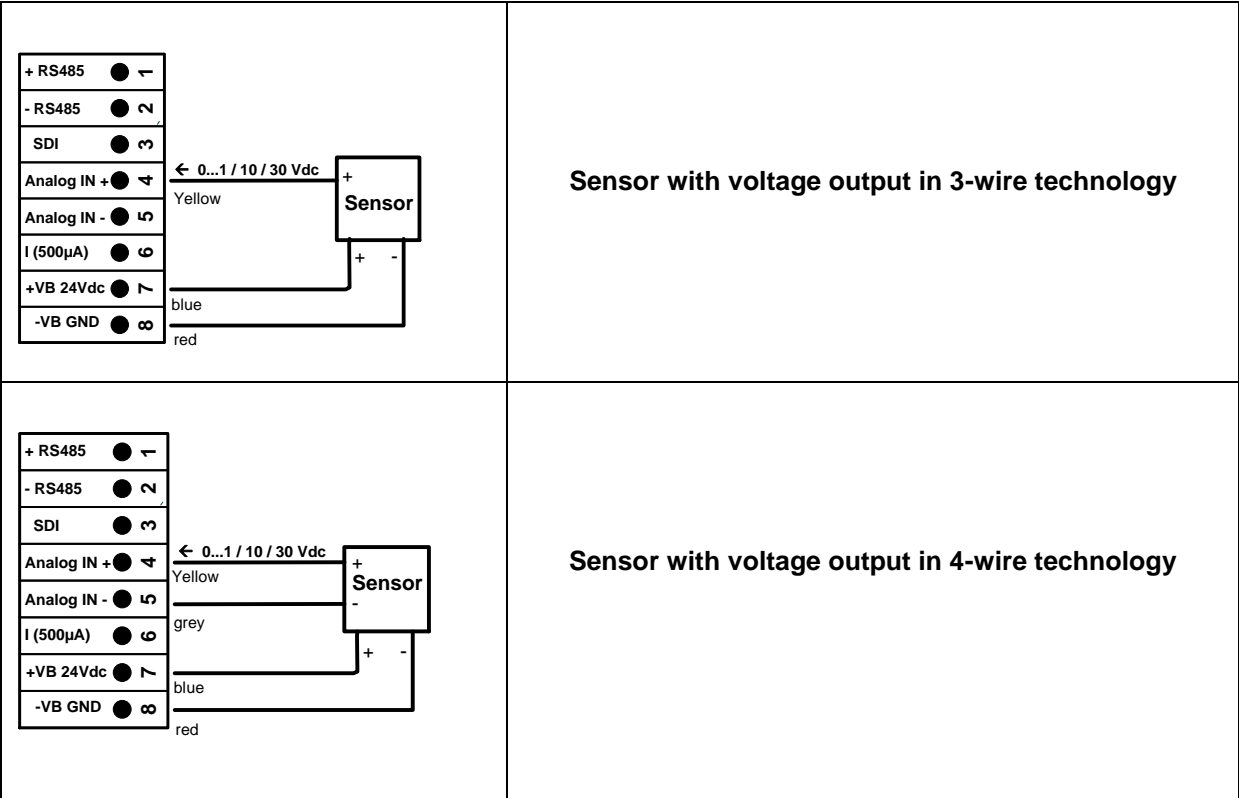

Connection diagrams of the different sensor types

6.8 Two-, three- and four-wire connector pin assignments for PT100/PT1000/KTY81

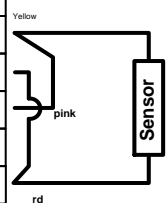
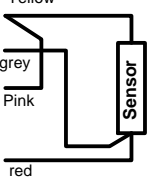
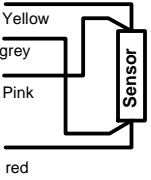
<table border="1"> <tr><td>+ RS485</td><td>●</td><td>1</td></tr> <tr><td>- RS485</td><td>●</td><td>2</td></tr> <tr><td>SDI</td><td>●</td><td>3</td></tr> <tr><td>Analog IN +</td><td>●</td><td>4</td></tr> <tr><td>Analog IN -</td><td>●</td><td>5</td></tr> <tr><td>I (500µA)</td><td>●</td><td>6</td></tr> <tr><td>+VB 24Vdc</td><td>●</td><td>7</td></tr> <tr><td>-VB GND</td><td>●</td><td>8</td></tr> </table> 	+ RS485	●	1	- RS485	●	2	SDI	●	3	Analog IN +	●	4	Analog IN -	●	5	I (500µA)	●	6	+VB 24Vdc	●	7	-VB GND	●	8	<p>2-wire PT100/PT1000/KTY81</p>
+ RS485	●	1																							
- RS485	●	2																							
SDI	●	3																							
Analog IN +	●	4																							
Analog IN -	●	5																							
I (500µA)	●	6																							
+VB 24Vdc	●	7																							
-VB GND	●	8																							
<table border="1"> <tr><td>+ RS485</td><td>●</td><td>1</td></tr> <tr><td>- RS485</td><td>●</td><td>2</td></tr> <tr><td>SDI</td><td>●</td><td>3</td></tr> <tr><td>Analog IN +</td><td>●</td><td>4</td></tr> <tr><td>Analog IN -</td><td>●</td><td>5</td></tr> <tr><td>I (500µA)</td><td>●</td><td>6</td></tr> <tr><td>+VB 24Vdc</td><td>●</td><td>7</td></tr> <tr><td>-VB GND</td><td>●</td><td>8</td></tr> </table> 	+ RS485	●	1	- RS485	●	2	SDI	●	3	Analog IN +	●	4	Analog IN -	●	5	I (500µA)	●	6	+VB 24Vdc	●	7	-VB GND	●	8	<p>3-wire PT100/PT1000/KTY81</p>
+ RS485	●	1																							
- RS485	●	2																							
SDI	●	3																							
Analog IN +	●	4																							
Analog IN -	●	5																							
I (500µA)	●	6																							
+VB 24Vdc	●	7																							
-VB GND	●	8																							
<table border="1"> <tr><td>+ RS485</td><td>●</td><td>1</td></tr> <tr><td>- RS485</td><td>●</td><td>2</td></tr> <tr><td>SDI</td><td>●</td><td>3</td></tr> <tr><td>Analog IN +</td><td>●</td><td>4</td></tr> <tr><td>Analog IN -</td><td>●</td><td>5</td></tr> <tr><td>I (500µA)</td><td>●</td><td>6</td></tr> <tr><td>+VB 24Vdc</td><td>●</td><td>7</td></tr> <tr><td>-VB GND</td><td>●</td><td>8</td></tr> </table> 	+ RS485	●	1	- RS485	●	2	SDI	●	3	Analog IN +	●	4	Analog IN -	●	5	I (500µA)	●	6	+VB 24Vdc	●	7	-VB GND	●	8	<p>4-wire PT100/1000/KTY81</p>
+ RS485	●	1																							
- RS485	●	2																							
SDI	●	3																							
Analog IN +	●	4																							
Analog IN -	●	5																							
I (500µA)	●	6																							
+VB 24Vdc	●	7																							
-VB GND	●	8																							

6.9 Connection with RS485

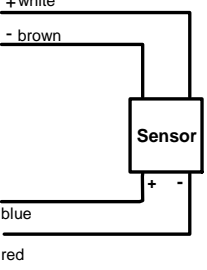
<table border="1"> <tr><td>+ RS485</td><td>●</td><td>1</td></tr> <tr><td>- RS485</td><td>●</td><td>2</td></tr> <tr><td>SDI</td><td>●</td><td>3</td></tr> <tr><td>Analog IN +</td><td>●</td><td>4</td></tr> <tr><td>Analog IN -</td><td>●</td><td>5</td></tr> <tr><td>I (500µA)</td><td>●</td><td>6</td></tr> <tr><td>+VB 24Vdc</td><td>●</td><td>7</td></tr> <tr><td>-VB GND</td><td>●</td><td>8</td></tr> </table> 	+ RS485	●	1	- RS485	●	2	SDI	●	3	Analog IN +	●	4	Analog IN -	●	5	I (500µA)	●	6	+VB 24Vdc	●	7	-VB GND	●	8	<p>Sensor with RS485 Interface</p>
+ RS485	●	1																							
- RS485	●	2																							
SDI	●	3																							
Analog IN +	●	4																							
Analog IN -	●	5																							
I (500µA)	●	6																							
+VB 24Vdc	●	7																							
-VB GND	●	8																							

7 Operation PI 500



The operation of the DP 500 7 DP 510 by means of a keypad and a touch panel

7.1 Keypad

7.1.1 On- and Off-button

On-or Off switching by long press  buttons.

7.1.2 Brightness buttons

With the button  and  the display brightness can be changed.

7.1.3 Screenshot-Button



By pressing the Screenshot-button, the actual display content will be stored.
Storage is possible either to a USB Stick or on to the internal SD-card

7.1.3.1 Storing Screenshot

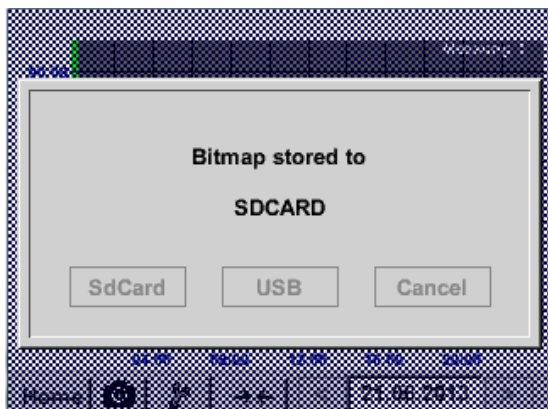
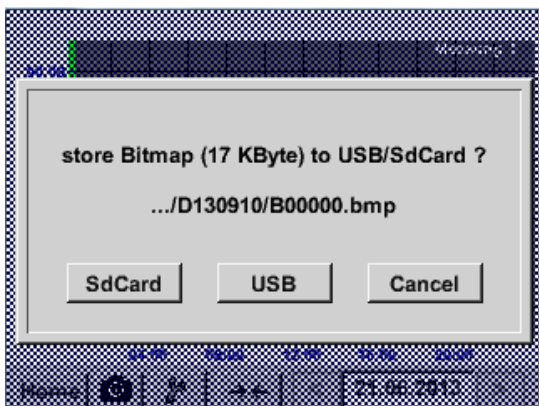

After pressing the Screenshot button a menu (see left) appears where the storage target, USB Stick or internal SD-card, could be selected.

The screens are stored as bitmap and the naming is a consecutively number. For every day, a new folder is created.

Folder definition; DJJMMTT
D=fix(for date)
JJ = year
MM= month
TT= day

Path: DEV0003/DP500/Bitmap

Example: first picture 10. September 2013

\\DEV0003/PI500/Bitmap/D130910/B00000.bmp

Operation PI 500 - Touchpanel

7.1.3.2 Export Screenshots

The stored bitmaps on the SD-card could be exported to a USB –Stick.

Main menu → Export Data

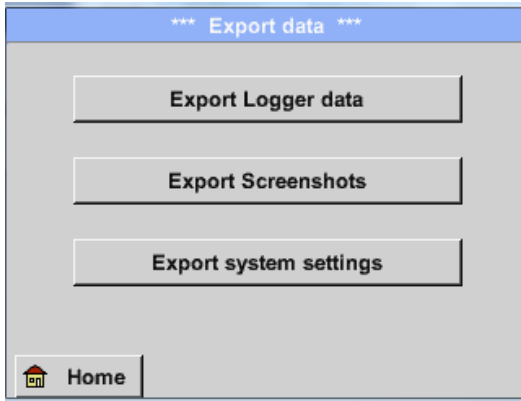

With *Export Screenshots* the stored Screenshots will be transferred to a USB-Stick.

Main menu → Export Data → Export Screenshots

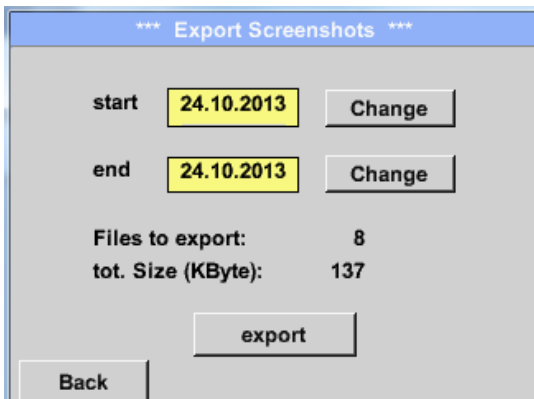

Use the *Change* buttons to adjust a period between *start* and *end*. Stored bitmaps data in this period are exported.

Main menu → Export Data → Export Screenshots → Change



The selected date is always green, and the date numbers of the Sundays are red, like in the calendar.

On days, where bitmaps were recorded, the date numbers are optical highlighted.

Operation PI 500 - Touchpanel

Main menu → Export Data → Export Screenshots → Export

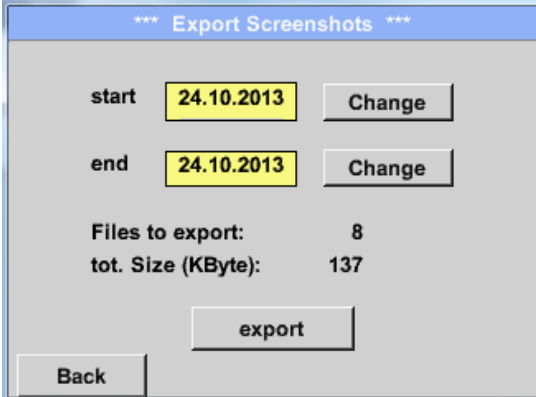

The Screenshots of the selected period are exported to the USB-Stick.

7.2 Touchpanel

The operation is largely self-explanatory and menu-driven via the touch panel. The selection of the respective menu items occur via short "tapping" with the finger or a soft round pen.

**Attention: Please use no pens or other objects with sharp edges!
The foil can be damaged!**

After sensors are connected, they also have to be configured.

Inputs or changes can be made with all white deposit fields. The measured values can be represented as a curve or values.

Words in **green font** refer mainly to the pictures in the section of the chapter, but also on important menu paths or menu items that are related to be in **green font**.

The menu navigation is generally in a **green font**!

The table of contents and chapter references in **blue font** contain links to the respective chapter title.

Main menu

7.3 Main menu (Home)

From the main menu, you can reach every available item.

7.3.1 Initialization

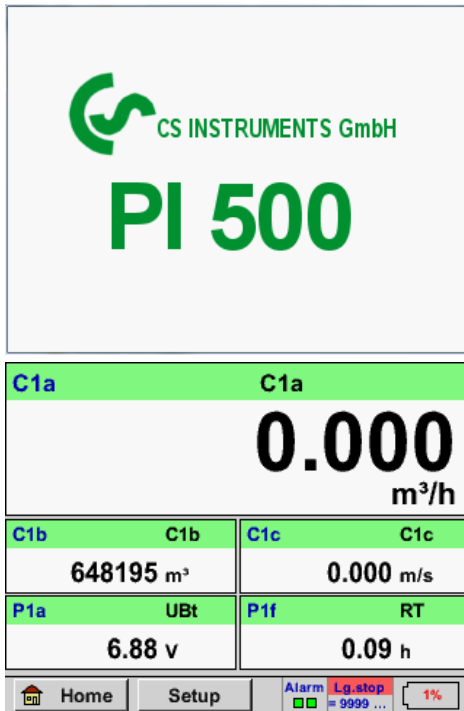

After switching on the PI 500 the channel is initialized and the menu „ *Real time values* „ appears.

Attention:

For the first initiation, there may be no external channel for PI 500 preset!

Please see chapter [7.3.2.1.2 Sensor Settings](#) then select appropriate configurations and set!

7.3.2 Main menu

Home

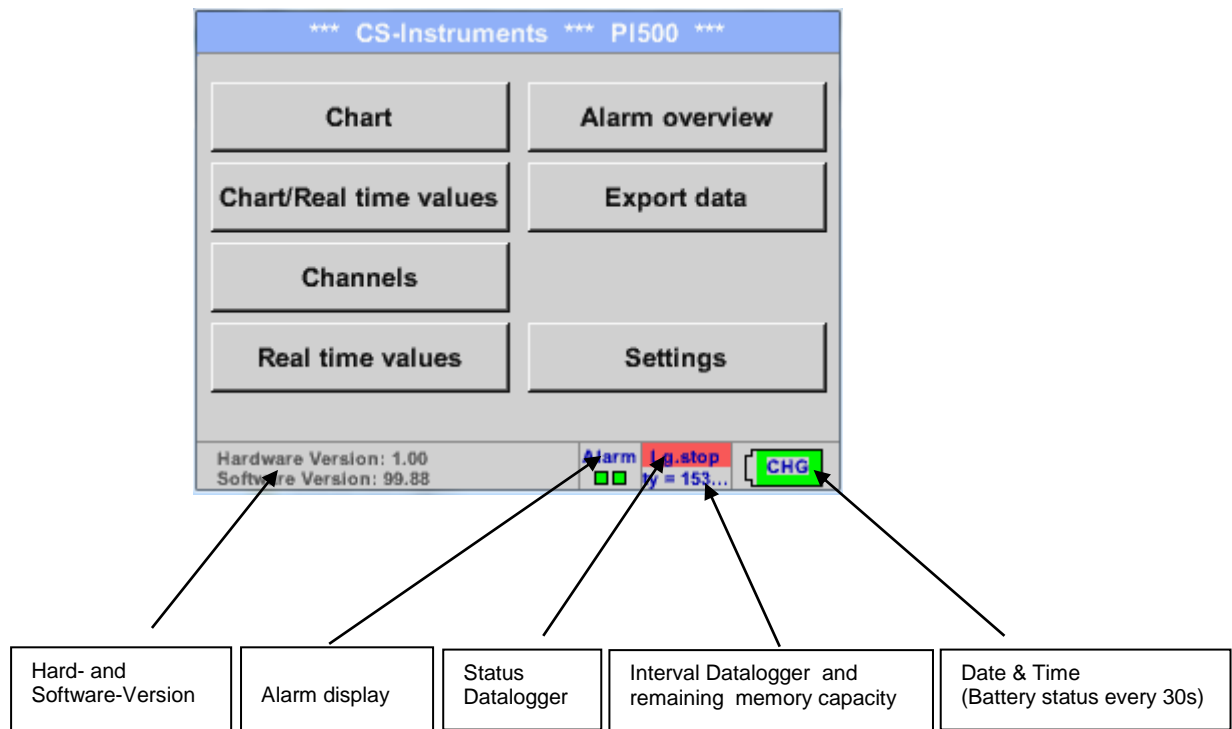

Important:

Before the first sensor setting is made, the language and time should be set!

Remark:

Chapter 7.3.2.1.4.1 language

Main → Settings → Device Settings → Set Language)

Chapter 7.3.2.1.4.2 Date & Time

Main → Settings → Device Settings → Date & Time)

7.3.2.1 Settings

The settings are all protected by a password!

Settings or changes are generally confirmed with **OK!**

Remark:

If you go back to main menu and then again one of the setting menus is called, you must enter the password again.

Main menu → Settings

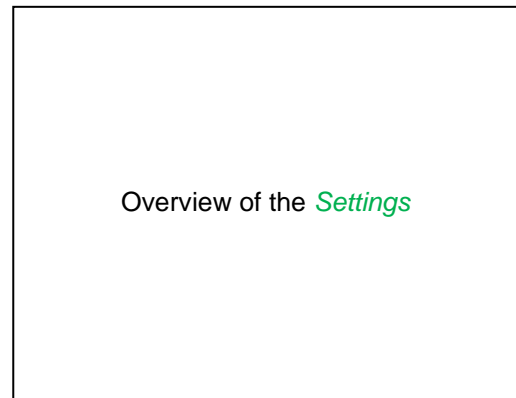
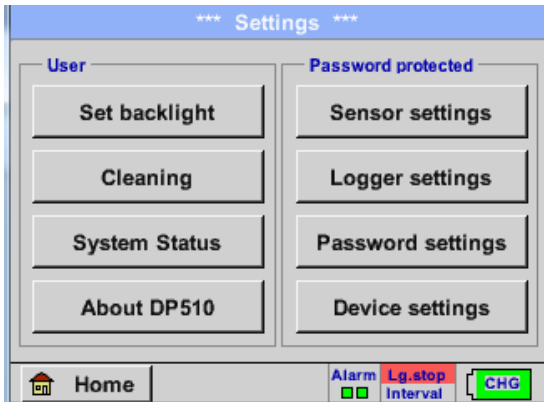

7.3.2.1.1 Password-Settings

Main menu → Settings → Password settings

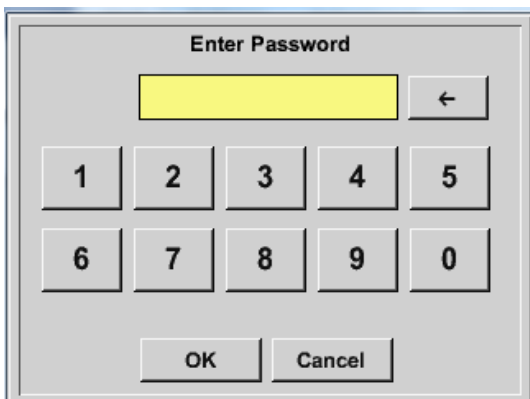

Factory settings for password at the time of delivery: 0000 (4 times zero).

If required, the password can be changed in the *Password settings*.

The new password must be entered two times in a row and in each case confirmed with **OK**

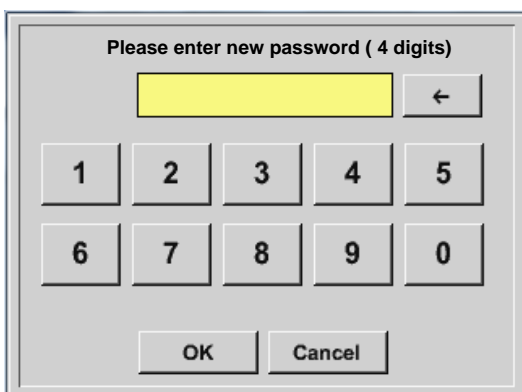

If an incorrect password is entered, there appears *Enter password* or *New password repeat* in red font.

If you can't remember the password, please use Master password in order to enter a new password.

Remark:

The master password is supplied together with the instrument's documentation.

Sensor-settings

7.3.2.1.2 Sensor-settings

Important:

Sensors from CS Instruments are generally pre-configured and can be connected directly to external sensor channel!

Main menu → Settings → Sensor settings

c1	
C1a	0.000 m³/h
C1b	648195 m³
C1c	0.000 m/s

Home Alarm Lg.stop 14.03.2014
val = 0 ... 11:19:56

The overview of the available channel appears after entering the password.

Remark:
Usually there is no preset for the external channel!

Sensor-settings

7.3.2.1.2.1 Choice of the sensor type (For example type CS-Digital sensor)

Main menu → Settings → Sensor settings → C1



If still no sensor has been configured, the *Type No Sensor* appears.

By pushing the description field *Type No Sensor* the list of sensor types appears (see next step).

Main menu → Settings → Sensor settings → C1 → Type description field → CS-Digital

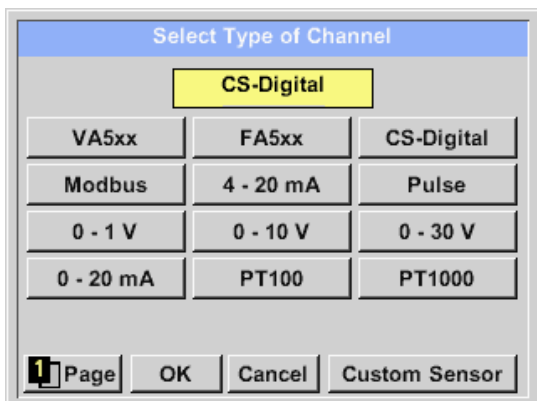

Now the *Type CS-Digital* is selected for the VA/FA 400 series and confirmed by pressing the *OK* button.

Sensor-Settings – Naming of measurement data

7.3.2.1.2.2 Name the measurement data and define the decimal places

Remark:

The *Resolution* of the decimal places, the *Short Name* and *Value Name* are found under the **Tool button!**



Tool Button:

Main menu → Settings → Sensor settings → C1 → Tool Button

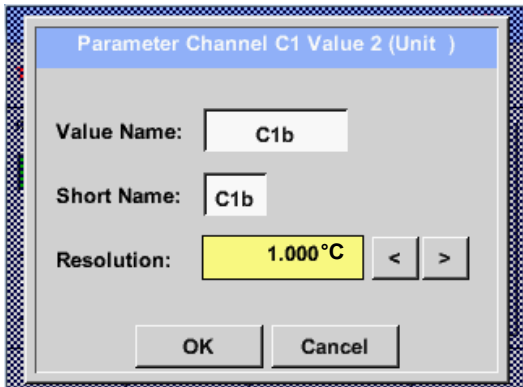

For the recorded *Value* there can be entered a *Name* with 10 characters and later in menu item *Graphics/Real time values* it is easier to identify it. Otherwise the *Name* is, for example, *C1b*. The channel name is *C1* and *a* is the first measurement data at the channel, the Second *b* and the Third *c*. The *Resolution* of the decimal places is simply adjustable by pushing right and left (0 to 5 decimal places).

See chapter 7.3.2.1.2.7 label and setting the description fields

7.3.2.1.2.3 Recording measurement data

Main menu → Settings → Sensor settings → C1 → Record Button

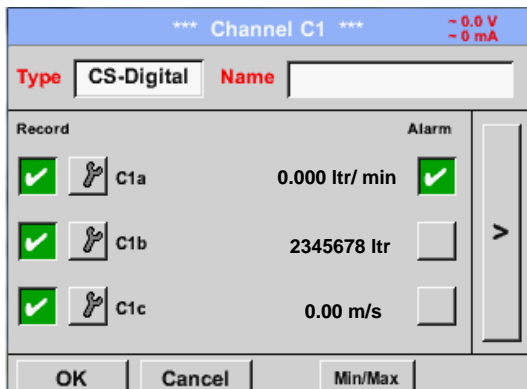

Use the *Record* buttons to select the measurement data that will be stored by **activated data logger**.

Attention:

Before the selected measurement data are recorded, the data logger must be activated after the settings (See chapter 7.3.2.1.3.2 [Logger-Settings\(Datalogger\)](#)).

Sensor-Settings / Alarm-Settings

7.3.2.1.2.4 Alarm-Settings (Alarm Popup)

Main menu → Settings → Sensor settings → C1 → → Alarm-Button

By pushing an alarm button, the following window appears:

In the alarm settings, an *Alarm 1* and *Alarm 2* incl. *Hysteresis* can be entered for each channel.

In the menu *Alarm overview* (can be reached from the main menu), the alarm settings are clearly represented.

Main menu → Settings → Sensor settings → C1 → → Alarm-Button → Alarm-1- und Alarm-2-buttons + Popup-buttons

Here for example the *Alarm-1* yellow and the *Alarm-2* red.

Main menu → Settings → Sensor settings → C1

After alarm setting for Channel C1a.

Remark:

After confirm with **OK**, the font is black again and the values and settings are accepted

Sensor-Settings / Alarm-Settings

7.3.2.1.2.5 More Settings (scale analogue output)

Main menu → Settings → Sensor settings → C1 → arrow right (2.page) → More settings

More-Settings C1-Luft-1

4...20mA Output of Sensor
Base

m³/h m/s

scale manual

4mA = 0.000 m/s

20mA = -1.0 m/s

Max Velocity 92.700 m/s

Calibration Data

Gas Air (287.0)

Temperat 293.0 °K

Pressure 1000.0 hPa

Area 110.0 mm²

Cal. Date 24.07.2013

OK Cancel

In *More-Settings*, you can define whether the 4 - 20 mA analogue output of the sensor based on the flow rate or velocity.

The green highlighted description field is selected!

In addition, you can push the *scale manual* button and set the measuring range.

After confirming with *OK*, the settings are assumed.

Remark:
More-Settings only for type **CS-Digital** available!

More-Settings C1-

4...20mA Output of Sensor
Base

m³/h m/s

scale manual

4mA = 0.000 m/s

20mA = 200.000 m/s

Max Velocity 92.700 m/s

Calibration Data

Gas Air (287.0)

Temperat 293.00 °K

Pressure 1000.00 hPa

Area 110.00 mm²

Cal. Date 03.07.2013

OK Cancel

The settings are completed after pressing the *OK* button!

Remark:

After confirming with *OK*, the font is black again and the values and settings are accepted.

Sensor-settings

7.3.2.1.2.6 Dew Point Sensor of type CS-Digital (SDI Bus)

First step: choose an unused sensor channel

Main menu → Settings → Sensor settings → C1

Second step: choose type CS-Digital

Main menu → Settings → Sensor settings → C1 → Type description field → CS-Digital

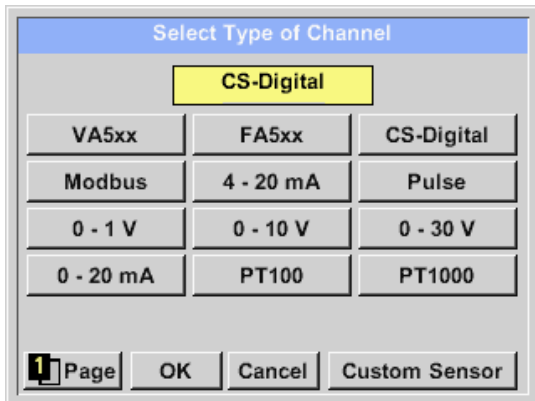

Now the *Type CS-Digital* is selected for the VA/FA 400 series and confirmed by pressing the *OK* button.

Main menu → Settings → Sensor settings → C1

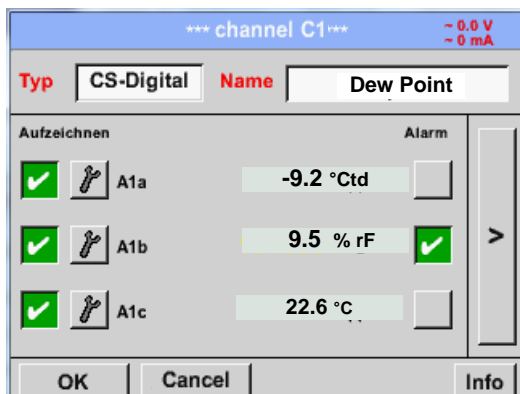

The PI 500 detects, if the connected sensor is a flow or dew point sensor of **CS Instruments** and set the *CS-Digital* subtype automatically correct.

Main menu → Settings → Sensor settings → C1 → description field Name

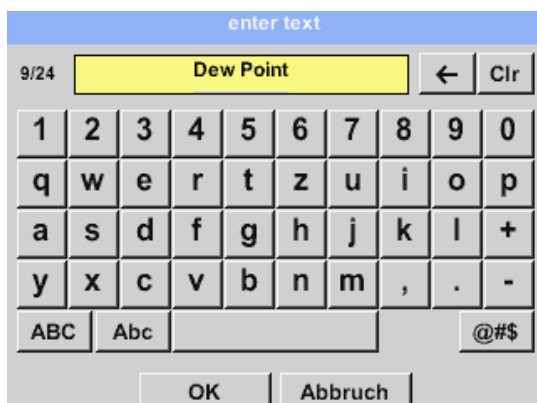

It is possible to enter a name with 24 characters.

Third step: confirm with *OK* two times

Sensor-settings

7.3.2.1.2.7 Consumption Sensor of type CS-Digital (SDI Bus)

First step: choose an unused sensor channel

Main menu → Settings → Sensor settings → C1

Second step: choose type CS-Digital

Main menu → Settings → Sensor settings → C1 → Type description field → CS-Digital

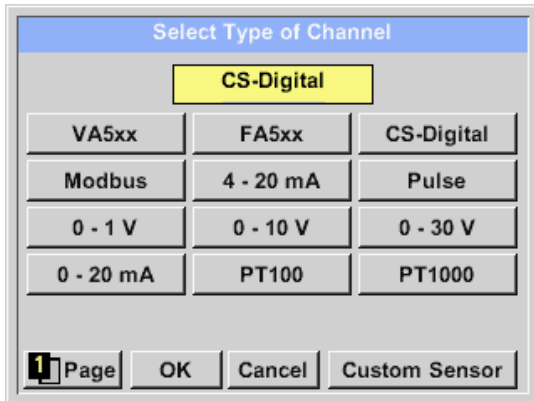

Now the *Type CS-Digital* is selected for the VA/FA 400 series and confirmed by pressing the **OK** button.

Main menu → Settings → Sensor settings → C1

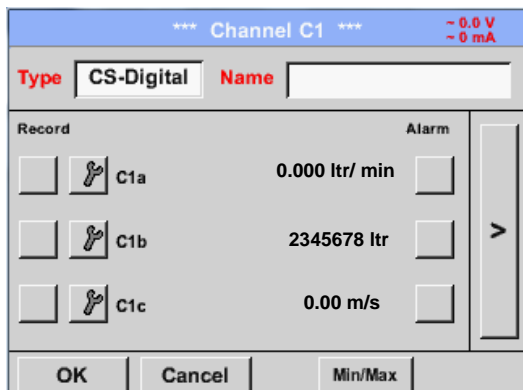

The PI 500 detects, if the connected sensor is a flow or dew point sensor of **CS Instruments** and set the **CS-Digital** subtype automatically correct.

Now, a **Name** (see Chapter 7.3.2.1.2.7 label and setting the description files), the **alarm settings** (see Chapter 7.3.2.1.2.4 Alarm-Settings) and the **recording-settings** (see Chapter 7.3.2.1.2.3 Recording measurement data) and the **Resolution** of the decimal places (see Chapter 7.3.2.1.2.2 Name measurement data and define the decimal places) can be determined.

Main menu → Settings → Sensor settings → C1 → description field Name

Sensor-settings

It is possible to enter a name with 24 characters.

Third step: confirm with **OK** two times

Main menu → Settings → Sensor settings → C1 → arrow right (2.page)

Record	Alarm	
<input type="checkbox"/> C1a	<input type="checkbox"/>	0.000 ltr/ min
<input type="checkbox"/> C1b	<input type="checkbox"/>	2345678 ltr
<input type="checkbox"/> C1c	<input type="checkbox"/>	0.00 m/s

By entering the white text fields the value could be added or changed content could be change

Main menu → Settings → Sensor settings → C1 → description field Unit

A preset selection of suitable *Units*.

Sensor-settings

Main menu → Settings → Sensor settings → C1 → arrow right (2.page) → description field of numerical value

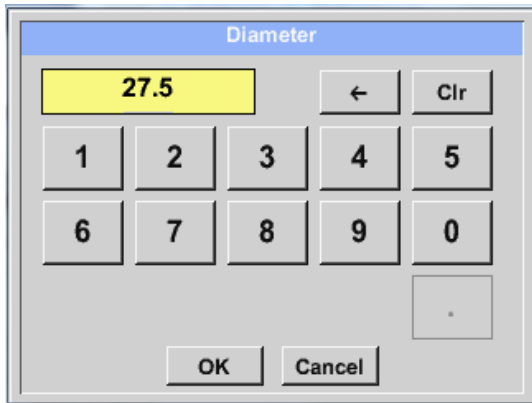

Important:

The *inner diameter* of flow tube can be entered here, if this was not automatically correctly set.

Inner diameter is entered here for example 27.5 mm.

Important:

The *inner diameter* should be entered as precisely as possible, because otherwise the measurement results are not correct!

There is no uniform standard for the tube *inner diameter*!
(Please, inquire at the manufacturer or measure by your own!)

Main menu → Settings → Sensor settings → C1 → arrow right (2.page) → Gas Constant description field

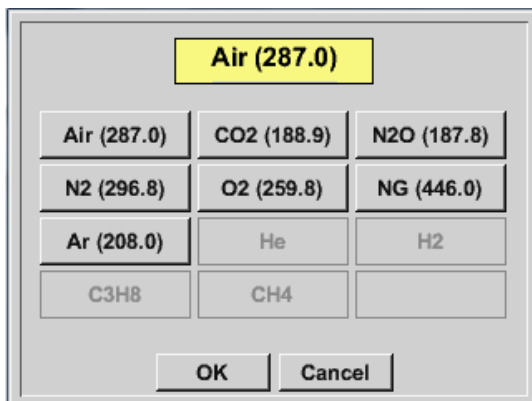

A preset selection of suitable *Gas Constants*.

Remark:

After confirming with **OK**, the font is black again and the values and settings are accepted.

Sensor-settings

7.3.2.1.2.8 Dew Point Sensor FA 500 / FA 510 of type FA 5xx (RS 485 Modbus)

First step: choose an unused sensor digital channel

Main menu → Settings → Sensor settings → C1

Second step: choose type FA 5xx

Main menu → Settings → Sensor settings → C1 → Type description field → FA 5xx

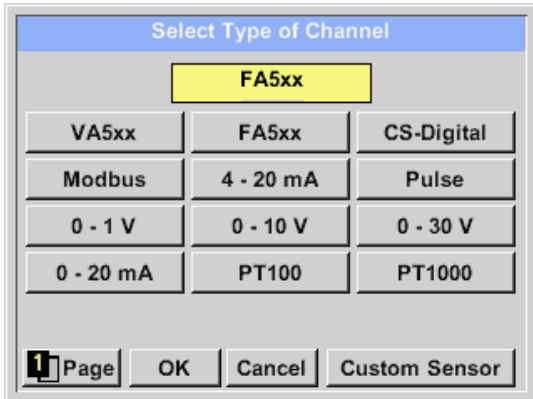

Now the *Type FA 5xx* is selected for the FA 5xx series and confirmed by pressing the *OK* button.

Now, a *Name* (see Chapter 7.3.2.1.2.7 label and setting the description files), the **alarm settings** (see Chapter 7.3.2.1.2.4 Alarm-Settings) and the **recording-settings** (see Chapter 7.3.2.1.2.3 Recording measurement data) and the *Resolution* of the decimal places (see Chapter 7.3.2.1.2.2 Name measurement data and define the decimal places) can be determined.



Input of a name, please enter the text field *„Name“*.

It is possible to enter a name with max. 24 characters.

Confirmation by pressing the *OK*-button.

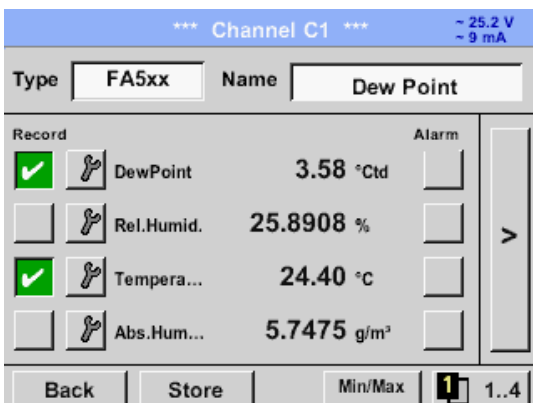
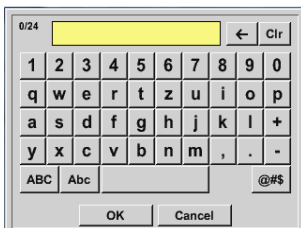

The connection with the FA 5xx sensor is done after confirmation by pressing *“OK”*.

Sensor-settings

7.3.2.1.2.8.1 Settings Dew point sensor FA 500 FA 510

7.3.2.1.2.8.1.1 Unit selection for temperature and humidity

Main menu → Settings → Sensor settings → C1 → arrow right (2.page)

*** Channel C1 *** ~ 25.2 V
~ 9 mA

Type FA5xx FA-Sensor
Id:1 19.2E1 To:250msec

Unit Temperature °C °F
Unit Abs.Humidity g/m³ mg/m³

Pressure Setting
Calibration

Back Store More-Settings Info

Unit selection for temperature and humidity by pressing the button °C, °F, g/m³ or mg/m³.

Confirm the settings by pressing the OK button.

7.3.2.1.2.8.1.2 Definition of the System pressure (relative pressure value)

Main menu → Settings → Sensor settings → C1 → arrow right (2.page) → Pressure Setting → Fixed

*** Channel C1 *** ~ 25.2 V
~ 9 mA

Type FA5xx FA-Sensor
Id:1 19.2E1 To:250msec

Unit Temperature °C °F
Unit Abs.Humidity g/m³ mg/m³

Pressure Setting
Calibration

Back Store More-Settings Info

The definition of the fixed value system pressure value is done by activating the button "fixed", but this is only required in case a ext. pressure probe is connected.

The value is entered in the corresponding text field. The unit can be freely selected, selection menu is opened by pressing the corresponding button units

Confirm the settings by pressing the OK button.

Pressure Setting

Ref.Pressure 1.013 bar

Mode fixed Sensor

Sys.Pressure 4.000 bar

OK Back

bar

mg/m ³	pa	hpa	kpa	Mpa
mbar	bar	psi		

OK Abbruch

Sensor-settings

7.3.2.1.2.8.1.3 Definition of Reference pressure (absolute pressure value)

Main menu → Settings → Sensor settings → C1 → arrow right (2.page) → Pressure Setting → Text field Ref.Pressure

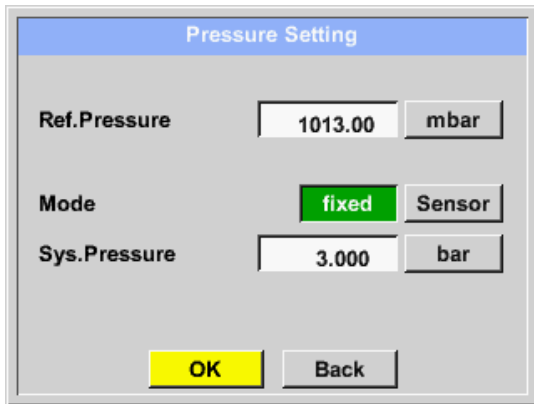

Pressure Setting

Ref.Pressure 1013.00 mbar

Mode fixed Sensor

Sys.Pressure 3.000 bar

OK Back

Reference pressure is the pressure for that the dew point in relaxation will be back-calculated.

Default- Value is 1013 mbar (Atm. Pressure).

Confirm the settings by pressing the **OK** button.

Sensor-settings

7.3.2.1.2.8.1.4 Calibration

Main menu → Settings → Sensor settings → C1 → arrow right (2.page) → Calibration

Calibration

Realtime Value 26.45 °Ctd

Reference Value °Ctd

Calibrate Reset

Counter 0 Back Δ rel.Humid. 0.000 %rH

Calibration

Realtime Value 103.556 °Ctd

Reference Value °Ctd

Calibrate Reset

Counter 0 Back Δ rel.Humid. 0.000 %rH

Here, a one-point calibration can be performed.

For that purpose, please enter in the text box "*Reference Value*" the new correct dew point value.

Then by pressing the "Calibration" button taking over the inserted reference value.

Calibration can be put back to factory setting by pressing "*Reset*".

For each performed calibration, the counter is increased by 1.

7.3.2.1.2.8.1.5 More Settings Analogue output 4-20mA

Main menu → Settings → Sensor settings → C1 → arrow right (2.page) → More-Settings → 4-20mA

4-20mA Settings

None	Temp °C	Temp °F	rH	DP °C
DP °F	AbsHu(g)	AbsHu(mg)	HumGrd	VapRat
SatVapPr	ParVapPr	ADP °C	ADP °F	

4mA = °C

20mA = °C

ErrorVal.

OK Abbruch

This menu allows the adjustment / assignment of the measurement value and the scaling of the analogue output.

Selection of the measurement value by selecting the appropriate measured value key in this example, "*DP °C*" for dew point ° Ctd.

In text fields "*4mA*" and "*20mA*" the appropriate scaling values are entered, here from -80 ° Ctd (4mA) to -20 ° Ctd (20mA).

With "*Error Val*" is determined what is output in case of error at the analog output.

- <3.6 Sensor error / System error
- 22 Sensor error / System error
- 4..20 Output according Namur (3.8mA – 20.5 mA)
< 4mA to 3.8 mA Measuring range under range
>20mA to 20.5 mA Measuring range exceeding

Sensor-Setting / Label and setting the description fields

7.3.2.1.2.9 Flow sensor of type VA 5xx (RS 485 Modbus)

First step: choose an unused sensor digital channel

Main menu → Settings → Sensor settings → C1

Second step: choose type VA 5xx

Main menu → Settings → Sensor settings → C1 → Type description field → VA 5xx

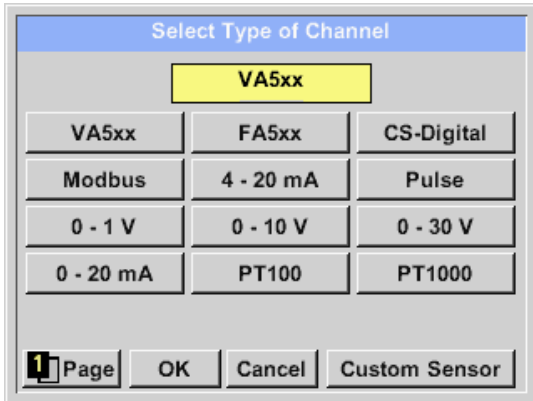

Now the *Type VA 5xx* is selected for the VA 5xx series and confirmed by pressing the **OK** button.

Now, a *Name* (see Chapter 7.3.2.1.2.7 label and setting the description files), the **alarm settings** (see Chapter 7.3.2.1.2.4 Alarm-Settings) and the **recording-settings** (see Chapter 7.3.2.1.2.3 Recording measurement data) and the *Resolution* of the decimal places (see Chapter 7.3.2.1.2.2 Name measurement data and define the decimal places) can be determined.

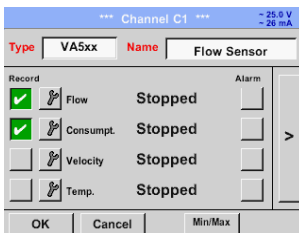

Input of a name, please enter the text field „*Name*“.

It is possible to enter a name with max. 24 characters.

Confirmation by pressing the **OK**-button.

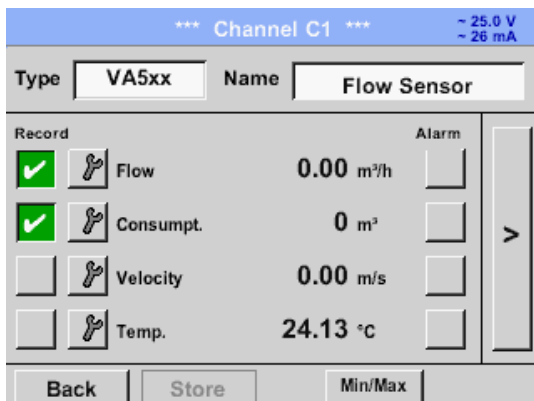
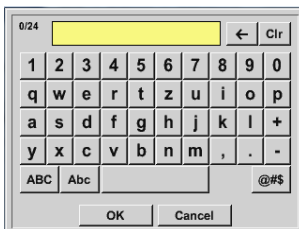

The connection with the VA 5xx sensor is done after confirmation by pressing **“OK”**.

Sensor-settings

7.3.2.1.2.9.1 Settings for Flow sensor VA 5xx

Main menu → Settings → Sensor settings → C1 → arrow right (2.page)

For each text field could be the either a value or a unit be set.

Settings by entering the text field and then input a value or select the unit for the appropriate field.

In case of VA 520 and VA 570 with integrated measuring section the diameter and diameter unit field are not access able.

7.3.2.1.2.9.2 Diameter settings (only for VA 500 or VA 550)

Main menu → Settings → Sensor settings → C1 → arrow right (2.page) → diameter description field

Important:

Only for VA 500 or VA 550 possible to change the *inner diameter*

In

Please confirm by pressing the *OK* button and go back with *arrow left (1.page)*.

Important:

The *inner diameter* should be entered as precisely as possible, because otherwise the measurement results are not correct!

There is no uniform standard for the tube *inner diameter*!
(Please, inquire at the manufacturer or measure by your own!)

Main menu → Settings → Sensor settings → C1 → arrow right (2.page) → diameter unit description field

After pressing the *Unit* Text fields following units bare selectable.

Sensor-settings

7.3.2.1.2.9.3 Gas Constant settings

Main menu → Settings → Sensor settings → C1 → arrow right (2.page) → Gas Constant description field

Air (real)		
Air (real)	CO2 (real)	H2 (real)
NO2 (real)	CO2 (188.9)	N2O (187.8)
N2 (296.8)	O2 (259.8)	NG (446.0)
Ar (208.0)		
OK Cancel		

All gases marked in blue and with (real) have been a real gas calibration curve stored in the sensor.

Select the gas you require and confirm selection by pressing **OK** button.

Attention:

Reference temperature and reference pressure (factory setting 20 °C, 1000 hPa):
All volume flow values (m³/h) and consumption values indicated in the display are related to 20 °C, 1000 hPa (according to ISO 1217 intake condition)
0 °C and 1013 hPa (= standard cubic meter) can also be entered as a reference.
Do not enter the operation pressure or the operation temperature under reference conditions!

Sensor-settings

7.3.2.1.2.9.4 Definition of the reference conditions

Here, the desired measured media reference conditions for pressure and temperature can be defined

Main menu → Settings → Sensor settings → C1 → arrow right (2.page) → Ref. Pressure description field

Main menu → Settings → Sensor settings → C1 → arrow right (2.page) → Ref. Pressure Unit description field

The first screenshot shows a numeric keypad titled "Ref. Pressure" with the value "1000" displayed. The keypad includes buttons for digits 0-9, a decimal point, a left arrow, and a "Clr" button. Below the keypad are "OK" and "Cancel" buttons.

The second screenshot shows a unit selection screen titled "mbar" (highlighted in yellow). It features a grid of unit options: "mbar", "psi", "hpa", and several empty cells. "OK" and "Cancel" buttons are at the bottom.

Main menu → Settings → Sensor settings → C1 → arrow right (2.page) → Ref. Temp. description Field

Main menu → Settings → Sensor settings → C1 → arrow right (2.page) → Ref. Temp. Unit description Field

The first screenshot shows a numeric keypad titled "Ref. Temp." with the value "20" displayed. The keypad includes buttons for digits 0-9, a decimal point, a left arrow, and a "Clr" button. Below the keypad are "OK" and "Cancel" buttons.

The second screenshot shows a unit selection screen titled "°C" (highlighted in yellow). It features a grid of unit options: "°C", "°F", and several empty cells. "OK" and "Cancel" buttons are at the bottom.

7.3.2.1.2.9.5 Definition Unit of flow and velocity

Main menu → Settings → Sensor settings → C1 → arrow right (2.page) → Flow description Field

Main menu → Settings → Sensor settings → C1 → arrow right (2.page) → Velocity description Field

The first screenshot shows a unit selection screen titled "m³/h" (highlighted in yellow). It features a grid of flow unit options: "m³/h", "Nm³/h", "m³/min", "Nm³/min", "ltr/h", "Nltr/h", "ltr/min", "Nl/min", "ltr/s", "Nl/s", "cfm", "SCFM", "kg/h", "kg/min", "kg/s", and "kW". "OK" and "Cancel" buttons are at the bottom.

The second screenshot shows a unit selection screen titled "m/s" (highlighted in yellow). It features a grid of velocity unit options: "m/s", "Nm/s", "fpm", "SFPM", and several empty cells. "OK" and "Cancel" buttons are at the bottom.

Sensor-settings

7.3.2.1.2.9.6 Definition consumption counter value and consumption unit

Main menu → Settings → Sensor settings → C1 → arrow right (2.page) → Count Val. description Field

Main menu → Settings → Sensor settings → C1 → arrow right (2.page) → Count Val. Unit description Field

The first screenshot shows a 'Consumption' dialog box. At the top, the word 'Consumption' is in a blue header. Below it, a yellow box contains the number '4589'. To the right of this box are two buttons: a left arrow and 'Clr'. Below the yellow box is a numeric keypad with buttons for digits 1-9 and 0. At the bottom of the dialog are 'OK' and 'Cancel' buttons.

The second screenshot shows a unit selection dialog box. At the top, a yellow box contains 'm³'. Below it is a grid of unit buttons: m³, Nm³, ltr, Nltr, cf, SCF, kg, kWh, and several empty cells. At the bottom are 'OK' and 'Cancel' buttons.

The sensor allows taking over a starting counter value. Inserting the value by entering the "Count. Val." text field.

In the Count. Val. Unit field different units could be used. Selection by activation of the "Count. Val. Unit" text field

In case the counter value unit will be changed only the consumption counter value will be recalculated to the appropriate unit.

Selection to confirm selection by pressing **OK** button.

Important!

When the counter reach 10000000 m³ the counter will be reset to zero.

The screenshot shows the 'Channel C1' settings screen. At the top, it says '*** Channel C1 ***' and shows voltage and current levels: '~ 25.0 V' and '~ 60 mA'. Below this, the sensor type is 'VA5xx' and the sensor is identified as 'VA-Sensor'. The screen is divided into several sections for parameter settings:

- Flow:** m³/h
- Velocity:** m/s
- Diameter:** 53.100
- Unit:** mm
- Gas Constant:** Air (real) J/Kg*k
- Ref. Pressure:** 1000.00
- Unit:** mbar
- Ref. Temp.:** 20.000
- Unit:** °C
- Count.Val:** 0
- Unit:** m³

At the bottom of the screen are four buttons: 'Back', 'Store', 'More-Settings', and 'Info'.

Remark:

After confirmation with **OK**, the font is black again and the values and settings are accepted

7.3.2.1.2.9.7 Settings analogue output 4-20mA of VA 5xx

Main menu → Settings → Sensor settings → C1 → More-Settings → 4-20mA Ch1

Main menu → Settings → Sensor settings → C1 → More-Settings → 4-20mA Ch1

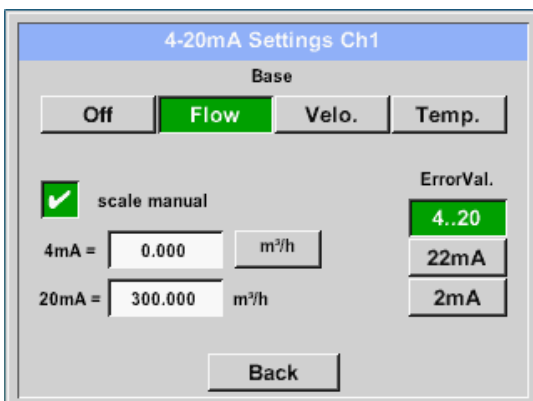
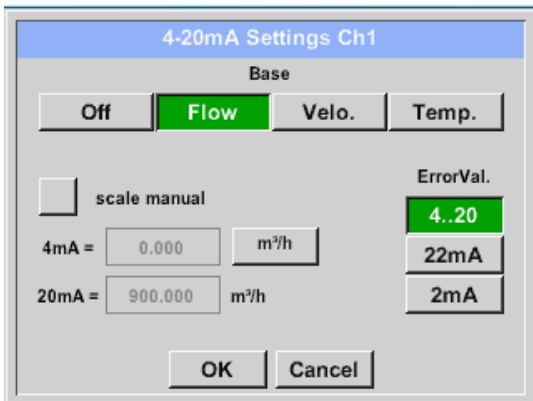
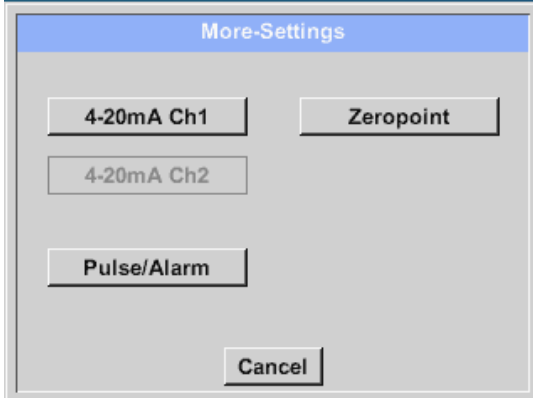

This menu allows the adjustment / assignment of the measurement value and the scaling of the analogue output by pressing the "4-20mA Ch1" button.

Selection of the analogue output measurement value by activating the appropriate measured value key in this example, "Flow".

Possible outputs are flow, velocity and temperature. In case of no use, please select "Off".

The analogue output scaling have to possibilities, automatic scaling (default) and a manual scaling by the user. Auto scaling is based on the calibration settings, means 4mA is set to zero and the 20mA value is based on the max. settings here 900m³/h

A "manual scaling" needs an activation of the "scale manual" button.

In text fields "4mA" and "20mA" the appropriate scaling values are entered, here from zero m³/h (4mA) to 300 m³/h (20mA).

With "Error Val" it is determined what is the output in case of an error at the analogue output.

- 2 mA Sensor error / System error
- 22 mA Sensor error / System error
- 4..20 Output according Namur (3.8mA – 20.5 mA)
 < 4mA to 3.8 mA Measuring range under range
 >20mA to 20.5 mA Measuring range exceeding

Inputs / changes to be confirmed with "OK" button. Return to main menu with "Back".

Sensor-settings

7.3.2.1.2.9.8 Settings Pulse / Alarm output of VA 5xx

Main menu → Settings → Sensor settings → C1 → More-Settings → Pulse / Alarm

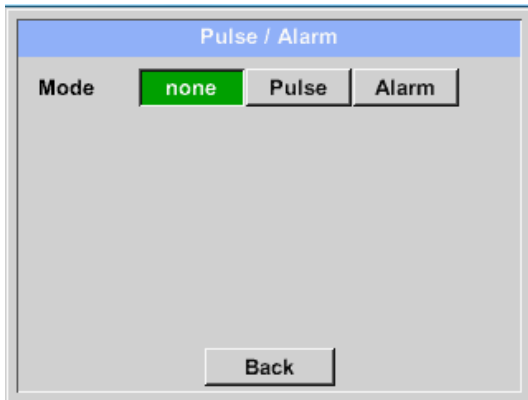

The pulse output of the VA 5xx could be set functionally as pulse output or alarm output.

Function to activate by pressing either the "Pulse" or "Alarm" button.

In case of no use, please select "none".

Inputs / changes to be confirmed with "OK" button. Return to main menu with "Back".

Main menu → Settings → Sensor settings → C1 → More-Settings → Pulse

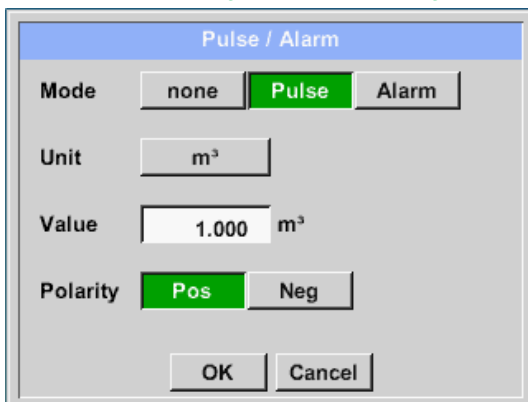

To set up the pulse first the unit and the measurement value have to be defined.

Unit selection by pressing "unit" button and choice one of the possible units "kg", "cf", "ltr" or "m³".

Pulse weight setting by entering the text field "Value".

Here with defined 1 pulse per m³ and with positive polarity.

With "Polarity" the switching state could be defined.

Pos. = 0 → 1 neg. 1 → 0

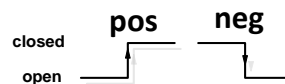

Inputs / changes to be confirmed with "OK" button. Return to main menu with "Back".

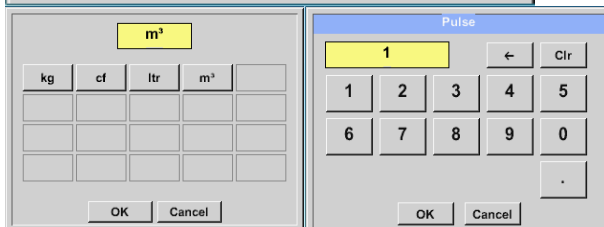

Main menu → Settings → Sensor settings → C1 → More-Settings → Alarm

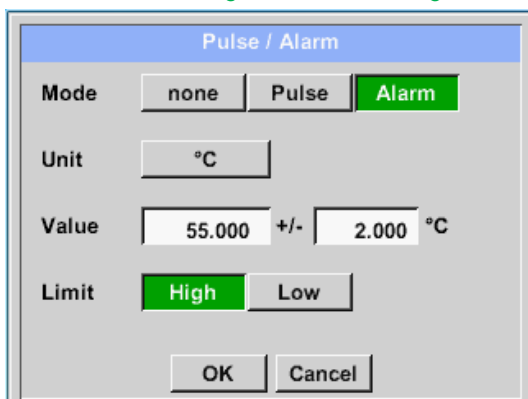

In case of use the pulse output as alarm following definitions needs to be set:

Unit selection by pressing "unit" button and choice one of the possible units "cfm", "ltr/s", "m³/h", "m/s", "°F", "°C", "kg/s" or "kg/min".

Alarm value setting by entering the text fields "Value".

The limits "High" or "Low" defines when the alarm is activated, selecting by pressing the appropriate button

High: Value over limit

Low: Value under limit

Inputs / changes to be confirmed with "OK" button. Return to main menu with "Back".



Sensor-settings

7.3.2.1.2.9.9 Settings ZeroPoint or Low Flow Cut off for VA 5xx

Main menu → Settings → Sensor settings → C1 → More-Settings → Zeropoint

Zero Setup

Actual Flow 2.045

ZeroPoint

CutOff

Reset

Back

Zero Setup

Actual Flow 200.732

ZeroPoint

CutOff

Reset

OK Cancel

Zero Setup

Actual Flow 2.045

ZeroPoint

CutOff

Reset

OK Cancel

With these function following adjustments for the sensor VA 5xx could be done:

Zeropoint:

When, without flow, the installed sensor shows already a flow value of $> 0 \text{ m}^3/\text{h}$ herewith the zero point of the characteristic could be reset

Cutoff:

With the low-flow cut off activated, the flow below the defined "LowFlow Cut off" value will be displayed as $0 \text{ m}^3/\text{h}$ and not added to the consumption counter.

For Zero Point the text field "ZeroPoint" to enter and insert the displayed actual flow, here 2.045

For inserting low flow cutoff value activate the text field "CutOff" and insert the required value, here 10.

With the "Reset" button all entries could be set back to zero.

Inputs / changes to be confirmed with "OK" button. Return to main menu with "Back".

Sensor-Settings / Configuration of Analogue -Sensors

7.3.2.1.2.10 Configuration of Analogue-Sensors

A brief overview of the possible *Type* of settings with examples.

For *CS-Digital* see chapter [7.3.2.1.2.2 Choice of the sensor type \(For example type CS-Digital sensor\)](#) and [7.3.2.1.2.6 Dew Point sensor with type CS-Digital](#) and [7.3.2.1.2.7 Consumption Sensor of type CS-Digital \(SDI Bus\)](#)

The *Alarm-settings*, *Record-Button*, the *Resolution* of the decimal places and *Short Name* and *Value-Name* are all described in Chapter [7.3.2.1.2 Sensor-Settings](#).

7.3.2.1.2.11 Type 0 - 1/10/30 Volt and 0/4 – 20 mA

Main menu → Settings → Sensor settings → C1 → Type description field → 0 - 1/10/30 V

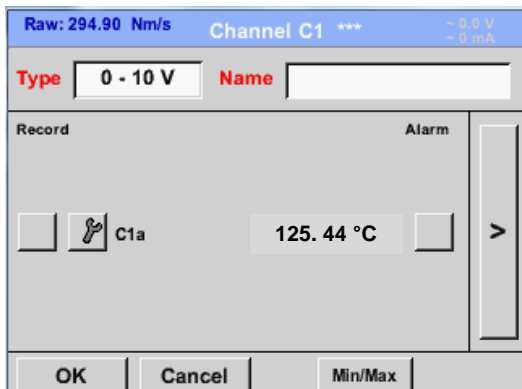

Please see the scale of the sensor (here for example *Type 0 - 10V* corresponds to 0 - 250 ° C) from the data sheet of the connected sensor.

By *Scale 0V* enter the lower and by *Scale10V* the upper scale value.

Main menu → Settings → Sensor settings → C1 → arrow right (2.page)

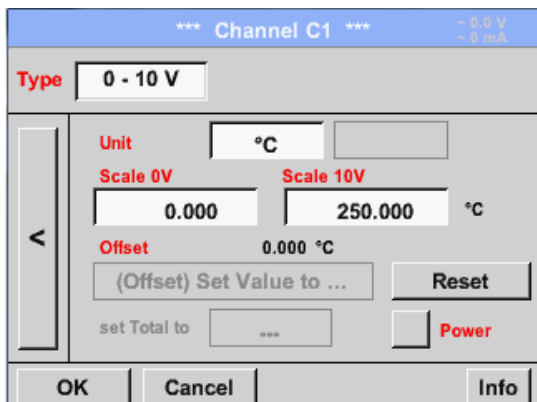

By *Scale 0V* enter the lower and by *Scale10V* the upper scale value

The *Sensor Supply Voltage* is switched *On*, if it's required by the sensor type, otherwise off (no green hook).

Please confirm by pressing the *OK* button

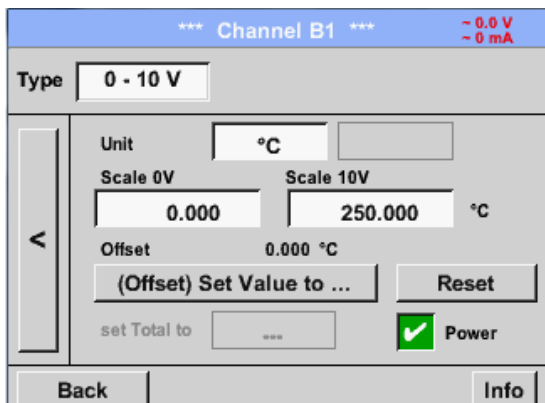

It is possible to define a *Offset-Value*. With the *Set Value to-button (Offset)* you enter it. The positive or negative difference of the *Offset* will be displayed.

By pressing the *Reset*-button the *Offset* will be deleted

Sensor-Settings / Configuration of Analogue sensors

Main menu → Settings → Sensor settings → C1 → arrow right (2.page) → description field Unit

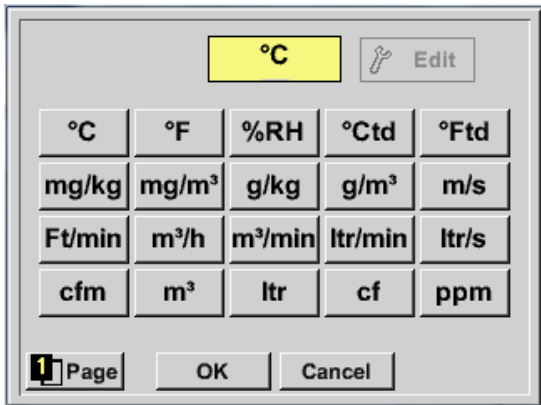

A preset selection of suitable units by **Type** 0 - 1/10/30 V and 0/4...20 mA.

The different pages could be displayed by pressing the **Page**-button.

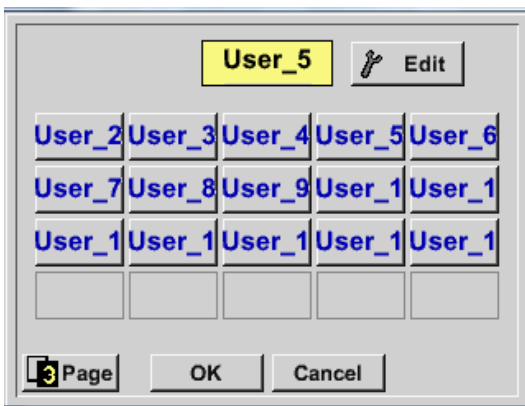

In addition **User** specific units could be defined

Here with the **Edit** button could analog to **description field** a User unit be defined.

Main menu → Settings → Sensor settings → C1 → Type description field → 0/4 - 20 mA

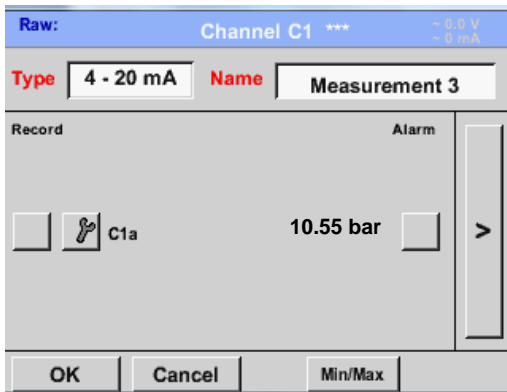

Here for example **Type 4 - 20 mA**.

Sensor-Settings / Configuration of Analogue sensors

7.3.2.1.2.12 Type PT100x and KTY81

Main menu → Settings → Sensor settings → B1 → Type description field → PT100x

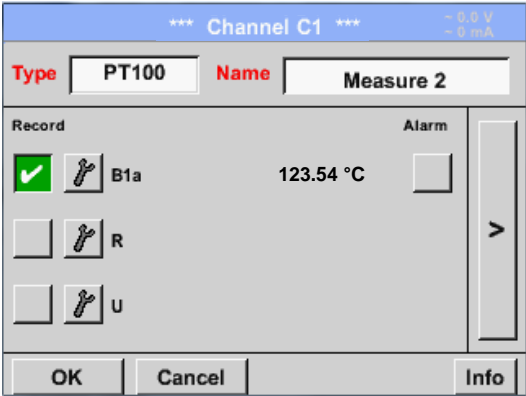

Here the sensor type *PT100* and the *Unit* in °C are chosen, alternatively the sensor types *PT1000* and *KTY81*, as well as the *Unit* °F can be selected.

More setting options, see chapter [7.3.2.1.2.9](#) Type 0 - 1/10/30 Volt and 0/4 - 20 mA!

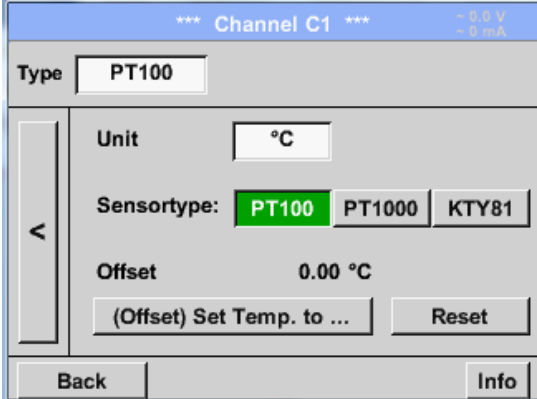

Sensor-Settings / Configuration of Analogue sensors

7.3.2.1.2.13 Type Pulse (Pulse ration)

Main menu → Settings → Sensor settings → B1 → Type description field → Pulse

Record	Value	Alarm
<input checked="" type="checkbox"/> B1a	9000 m ³ /h	<input type="checkbox"/>
<input checked="" type="checkbox"/> B1b	367001 m ³	<input type="checkbox"/>
<input type="checkbox"/> B1c	50 Hz	<input type="checkbox"/>

Typically the value with unit of **1 Pulse** is standing on the sensor and can directly entered to the **1 Pulse =** description field.

Remark:

Here, all description fields are already labeled or occupied.

1 Pulse = 0.005 m³

Unit	Pulse	Consumption	Counter
	m ³	m ³ /h	m ³

Counter: 367001 m³ Power

Main menu → Settings → Sensor settings → B1 → arrow right (2.page) → Unit Pulses

	ltr	m ³	Nltr	Nm ³
cf	Ncf	kg	kWh	PCS

By *Unit Pulse* you can choose between a flow volume or a power consumption unit.

Sensor-Settings / Configuration of Analogue sensors

Main menu → Settings → Sensor settings → B1 → arrow right (2.page) → Unit Consumption

The screenshot shows a configuration screen for 'Unit Consumption'. At the top, a yellow box contains the unit 'm³/h'. Below this is a grid of buttons. The first row contains 'm³/h' and 'm³/min', followed by three empty buttons. The next two rows each contain four empty buttons. At the bottom of the screen are 'OK' and 'Cancel' buttons.

Unit of current *Consumption* by *Type Pulse*

Remark:
Example with the unit cubic meters / hour

Main menu → Settings → Sensor settings → B1 → arrow right (2.page) → Unit Counter

The screenshot shows a configuration screen for 'Unit Counter'. At the top, a yellow box contains the unit 'm³'. Below this is a grid of buttons. The first row contains 'm³' and 'ltr', followed by three empty buttons. The next two rows each contain four empty buttons. At the bottom of the screen are 'OK' and 'Cancel' buttons.

The available Units for the *Unit of Counter* by *Type Pulse*

The **counter** can be set any time to any value you need.

More setting options, see chapter [7.3.2.1.2.9 Type 0 - 1/10/30 Volt and 0/4 - 20 mA](#)

7.3.2.1.2.14 Type „No Sensor“

Main menu → Settings → Sensor settings → C1 → Type description field → No Sensor

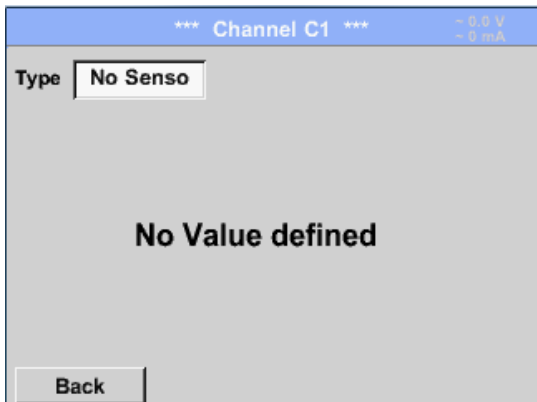

Is used to declare a not currently needed channel as *No Sensor* defined.

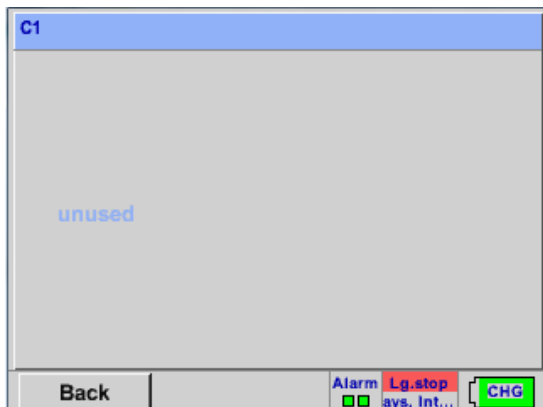

If you go to *Type No Sensor* Back, the channel will appear as *unused*.

7.3.2.1.2.15 Type Modbus

7.3.2.1.2.16 Selection and activation of Sensor-Type Modbus

First Step: First step: choose an unused sensor channel

Main menu → Settings → Sensor settings → C1

Second step: choose type Modbus

Main menu → Settings → Sensor settings → C1 → Type description field → Modbus

Third step: confirm with *OK*.

Now, a **Name** (see chapter 7.3.2.1.2.7 Label and setting the description fields) can be determined.

Main menu → Settings → Sensor settings → C1 → arrow right (2.page) → Va → use

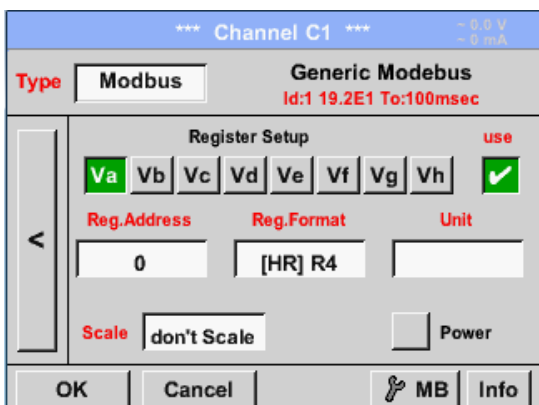

Via Modbus, it is possible to read out up to 8 Register-Values (from Input or Holding Register) of the sensor.

Selection by the Register Tabs *Va – Vh* and activation by pressing of the corresponding *Use* button.

7.3.2.1.2.16.1 Modbus Settings

Main menu → Settings → Sensor settings → C1 → arrow right (2.page) → Modbus Settings → ID - text field

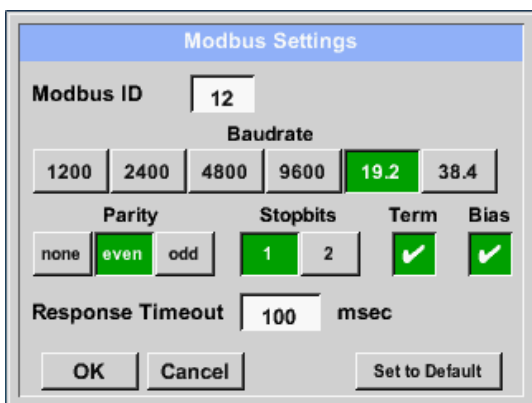

Please insert here the specified *Modbus ID* of the sensor, allowed values are 1 -247, (e.g. here *Modbus ID = 12*)

For setting the Modbus ID on the sensor, please see sensor-datasheet.

In addition in the menu are the serial transmission settings *Baudrate*, *Stopbit*, *Paritybit* and *Timeout* time to define.

In case that the DP 510 is the end of the RS485 bus system with activating *Term-* & *Bias-* button the required termination and biasing could be activated.

Confirmation by pressing *OK* button.

For resetting to the default values please press *Set to Default*.

Sensor-Settings / Type „Modbus“

Main menu → Settings → Sensor settings → C1 → Reg. Address description field

The measurement values are kept in the registers of the sensor and can be addressed via Modbus and read by the PI 500

This requires setting the desired register addresses in the PI 500

Entering the register / data address is here in decimal with 0-65535.

Important:

Required is the correct *register-address*.

It should be noted that the register-number could be different to the register-address (Offset). For this, please consult the sensor data sheet.

Main menu → Settings → Sensor settings → C1 → Reg. Format description field

With the buttons *Input Register* and *Holding Register* the corresponding Modbus-register type will be selected.

The number format and transmission order of each value needs to be defined by *Data Type* and *Byte Order*. Both have to be applied in correct combination.

Supported Data types:

Data Type:	UI1 (8b) = unsigned Integer	=>	0 - 255
	I1 (8b) = signed integer	=>	-128 - 127
	UI2 (16b) = unsigned Integer	=>	0 - 65535
	I2 (16b) = signed integer	=>	-32768 - 32767
	UI4 (32b) = unsigned Integer	=>	0 - 4294967295
	I4 (32b) = signed integer	=>	-2147483648 - 2147483647
	R4 (32b) = floating point number		

Byte Order:

The size of each Modbus-register is 2 Byte. For a 32 bit value two Modbusregister will be read out by the DS500. Accordingly for a 16bit Value only one register is read.

In the Modbus Specification, the sequence of the transmitted bytes is not defined clearly. To cover all possible cases, the byte sequence in the DS500 is adjustable and must adapted to the respective sensor. Please consult here for the sensor datasheet.

e.g.: High byte before Low Byte, High Word before Low Word etc.

Therefore the settings have to be made in accordance to the sensor data sheet.

Sensor-Settings / Type „Modbus“

Example:

Holding Register - UI1(8b) - Value: 18

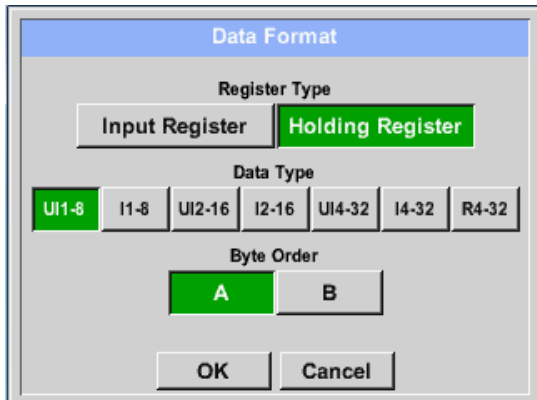

Selection Register Type *Holding Register*,
Data Type *UI1(8b)* und Byte Order *A / B*

	HByte	LByte
18 =>	00	12
Data Order	1. Byte	2. Byte
A	00	12
B	12	00

Holding Register – UI4(32) - Value: 29235175522 → AE41 5652

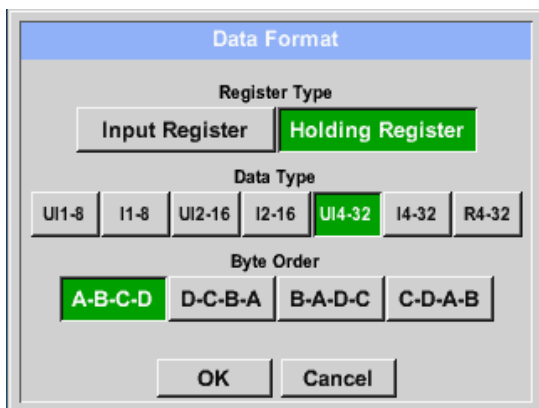

Selection Register Type *Holding Register*,
Data Type *UI1(32b)* und Byte Order *A-B-C-D*

	HWord		LWord	
	HByte	LByte	HByte	LByte
29235175522 =>	AE	41	56	52
Data Order	1.Byte	2.Byte	3.byte	4.Byte
A-B-C-D	AE	41	56	52
D-C-B-A	52	56	41	AE
B-A-D-C	41	AE	52	56
C-D-A-B	56	52	AE	41

Main menu → Settings → Sensor settings → C1 → Unit- description field

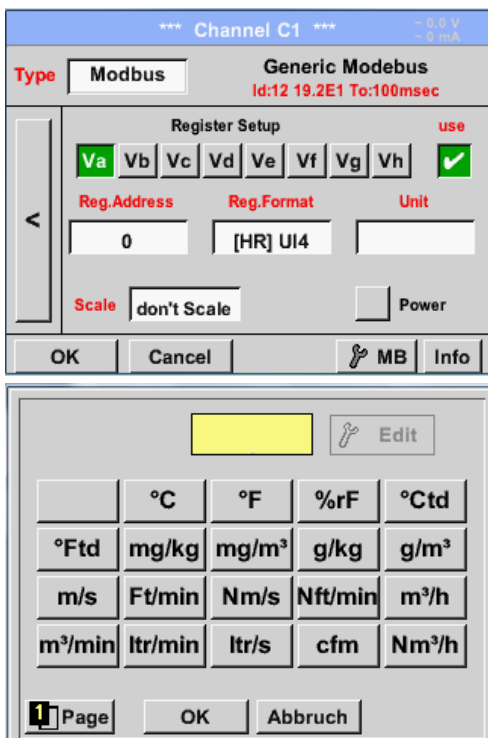

By pressing the description field *Unit*
the list with the available units appear

Please select the unit by pressing the
respective button e.g. *m³/h*.
For validation of the unit, please push the
button *OK*

To move through the list please press the
button *Page*.

In case the unit is **not** available it is possible
to create a user defined unit.

Therefore, please select one of the *User_X*
buttons.

Sensor-Settings / Type „Modbus“

Main menu → Settings → Sensor settings → C1 → Scale- description field

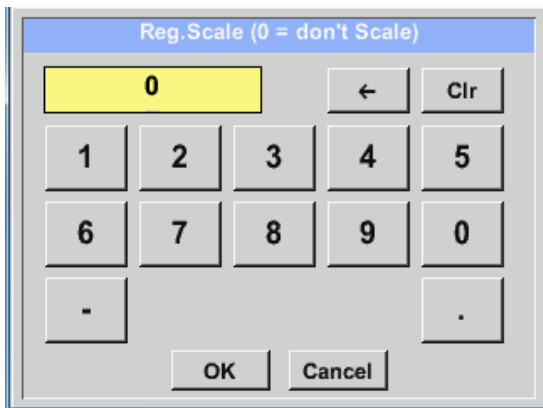

The screenshot shows a numeric keypad interface for setting the register scale. The title bar reads "Reg.Scale (0 = don't Scale)". The number "0" is currently displayed in a yellow highlighted box. The keypad includes buttons for digits 0-9, a decimal point, a minus sign, a left arrow, and a "Clr" button. At the bottom are "OK" and "Cancel" buttons.

The use of this factor allows adapting the output value by the same.

By default or value = 0 no scaling is applied and displayed in the field is *don't scale*

Main menu → Settings → Sensor settings → C1 → OK

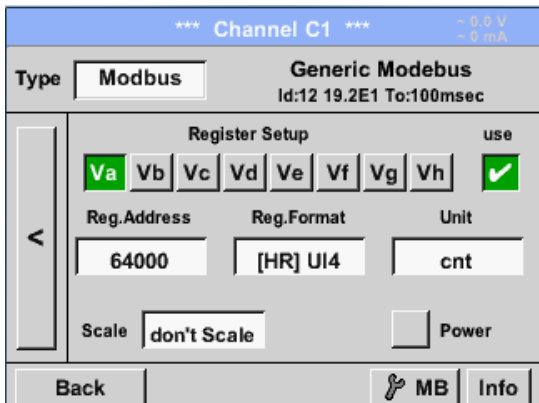

The screenshot shows the "Channel C1" configuration screen. The title bar indicates "*** Channel C1 ***" with a range of "- 0.0 V" and "- 0 mA". The "Type" is set to "Modbus" and the "Generic Modbus" settings are "Id:12 19.2E1 To:100msec". Under "Register Setup", the "use" checkbox is checked. The "Reg.Address" is "64000", "Reg.Format" is "[HR] UI4", and "Unit" is "cnt". The "Scale" is set to "don't Scale" and the "Power" checkbox is unchecked. At the bottom are "Back", "MB" (with a key icon), and "Info" buttons.

By pressing the *OK* button, the inputs are confirmed and stored.

Data logger settings

7.3.2.1.3 Data logger Settings

Main menu → Settings → Logger settings

*** Logger settings ***

Time interval (sec)

1 2 5 10 15 30 60 120 1

force new record file

Comment: -- no comment --

Logger stopped timed Start timed Stop

START STOP 1:36:00 - 29.1

Back Remaining logger capacity = 1531 days
Logging: 0 channels selected
time interval (min 1 sec)

In the top row you can select the predefined *Time intervals* 1, 2, 5, 10, 15, 30, 60 and 120 seconds for recording.

Time interval (sec)

20 ← Clr

1 2 3 4 5

6 7 8 9 0

OK Cancel

A different, individual *Time interval* can be entered in the highlighted white description field right at the head, where the currently set *Time interval* is always displayed.

Remark:

The largest possible *Time interval* is 300 seconds.

Remark:

If more than 12 measurement data are recorded at the same time, the smallest possible time interval of the data logger is 2 seconds.

In addition, if more than 25 measurement data are recorded at the same time, the smallest possible time interval of the data logger is 5 seconds.

Data logger settings

Main menu → Settings → Logger settings → force new Record File button

or

Main menu → Settings → Logger settings → force new Record File button → Comment description field

*** Logger settings ***

Time interval (sec)

1 2 5 10 15 30 60 120 1

force new record file

Comment: -- no comment --

Logger stopped timed Start timed Stop

START STOP 11:36:00 - 29.1 ---

Back

Remaining logger capacity = 1531 days
Logging: 0 channels selected
time interval (min 1 sec)

*** Logger settings ***

Time interval (sec)

1 2 5 10 15 30 60 120 1

force new record file

Comment: Messung 1

Logger stopped timed Start timed Stop

START STOP 11:36:00 - 29.1 ---

Back

Remaining logger capacity = 1531 days
Logging: 0 channels selected
time interval (min 1 sec)

A new recording file will be created by pushing the *force new record file* button and a name or comment can be entered by the choice of the *Comment* description field.

Important:

If a new recording file should be created, the *force new record file* button must be activated. Otherwise, the last applied recording file is used.

Main menu → Settings → Logger settings → timed Start button

*** Logger settings ***

Time interval (sec)

1 2 5 10 15 30 60 120 1

force new record file

Comment: Messung 1

Logger stopped timed Start timed Stop

START STOP 11:36:00 - 29.1 ---

Back

Remaining logger capacity = 1531 days
Logging: 0 channels selected
time interval (min 1 sec)

By pushing the *timed Start* button and then the date/time description field below, the date and the start time can be set for a data logger recording.

Remark:

If the start time is activated, it will automatically be set at the current time plus a minute.

Data logger settings

Main menu → Settings → Logger settings → timed Stop button

*** Logger settings ***

Time interval (sec)

1 2 5 10 15 30 60 120 1

force new record file

Comment: Messung 1

Logger stopped

timed Start timed Stop

START STOP 11:36:00 - 29.1 12:36:00 - 29.1

Back

Remaining logger capacity = 1531 days
Logging: 0 channels selected
time interval (min 1 sec)

By pushing the *timed Stop* button and then the date/time description field below, the date and the stop time can be set for a data logger recording.

Remark:

If the stop time activated, it will automatically be set to the current time plus an hour.

Main menu → Settings → Logger settings → timed Start button/timed Stop button
→ Date/Time description field

timed Start

11 : 40 : 00 29 · 11 · 13 Cal

1 2 3 4 5

6 7 8 9 0

OK Cancel

After pushing the *date/time description field* a window will appear where the yellow marked area of the time or date can always be set and changed.

Data logger settings

Main menu → Settings → Logger settings → timed Start button/timed Stop button
→ Date/Time description field → Cal button

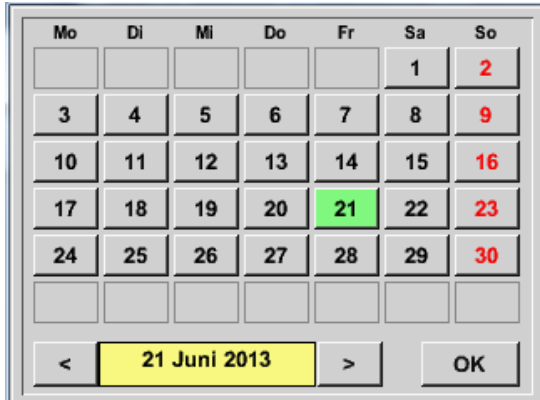

With the *Cal* button the desired date can be easily select from the calendar.

Main menu → Settings → Logger settings → Start button

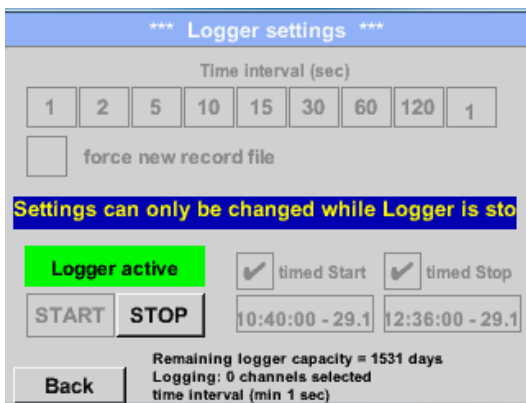

After the start and stop time activation and the created settings, the *Start* button will be pushed and the data logger is armed.

The data logger starts the recording at the set time!

Main menu → Settings → Logger settings → Start button/Stop button

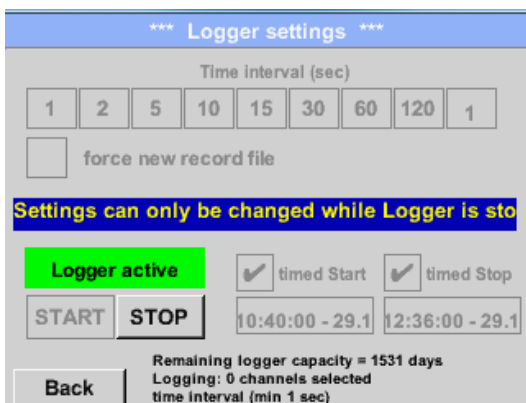

The data logger can be started without activated time settings, use the *Start* and *Stop* buttons for activate and disable. Left below there will be shown how many values are recorded and how long there still can be recorded.

Remark:

The settings cannot be changed, if the data logger runs.

Important:

If a new recording file should be created, the *force new record file* button must be activated. Otherwise, the last applied recording file is used.

Device - Settings / Language

7.3.2.1.4 Device Settings

Main menu → Settings → Device settings

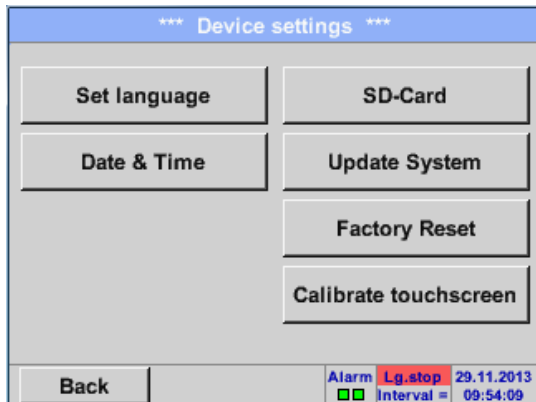

Overview of *Device settings*

7.3.2.1.4.1 Language

Main menu → Settings → Device settings → Set language



Here you can select one of 10 languages for the PI 500

7.3.2.1.4.2 Date & Time

Main menu → Settings → Device settings → Date & Time

*** Time & Date Settings ***

Actual Time Start

Time Zone UTC ±

Daylight Saving

Back Alarm Lg.stop 29.11.2013
ty = 1531 09:55:18

By pushing the *Time Zone* description field and enter the correct *UTC*, you can set the correct time all over the world.

*** Time & Date Settings ***

Actual Time Start

Time Zone UTC ±

Daylight Saving

Back Alarm Lg.stop 29.11.2013
pacity = 1 10:55:43

The summer and wintertime switchover is realized by pushing the *Daylight Saving* button.

7.3.2.1.4.3 SD-Card

Main menu → Settings → Device settings → SD-Card → Reset Logger Database

Main menu → Settings → Device settings → SD-Card → Erase SdCard

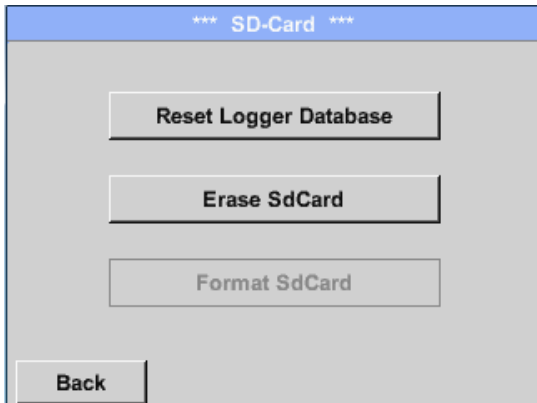

By pressing *Reset Logger Database* all actual stored data on SD-Card will be blocked for use in DS 400. Nevertheless all data are still stored and available for external use only.

By pressing *Erase SdCard* all Data on the SD-Card will be deleted.

System / Factory Reset

7.3.2.1.4.4 System update

Important!

System update can only be done with power supply connected to ensure there is a continuous power supply during the update.

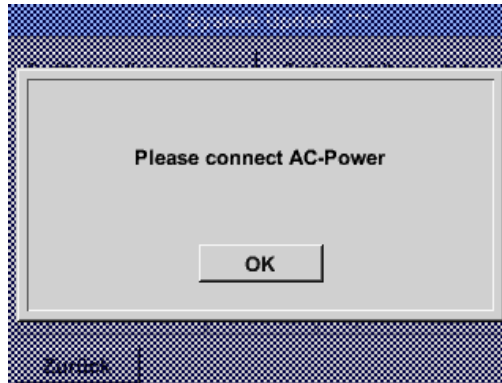

Main menu → Settings → Device settings → System-Update

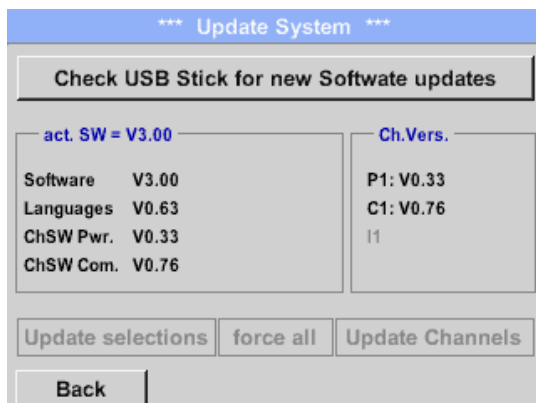

Overview of the [Update System](#) features

7.3.2.1.4.4.1 Check for new Software updates (USB)

Main menu → Settings → Device settings → Update System → Check USB Stick for new Software updates

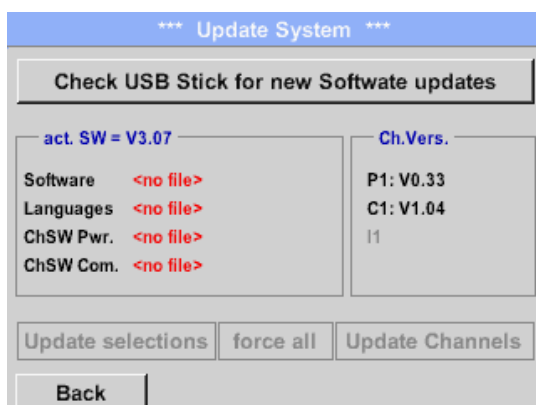

If after pushing the [Check USB Stick for new Software updates](#) button the following messages in the window appears, then PI 500 is not connected properly with the USB stick or no files are available.

Geräte-Einstellung / Datum & Uhrzeit

Main menu → Settings → Device settings → Update System → Update selections

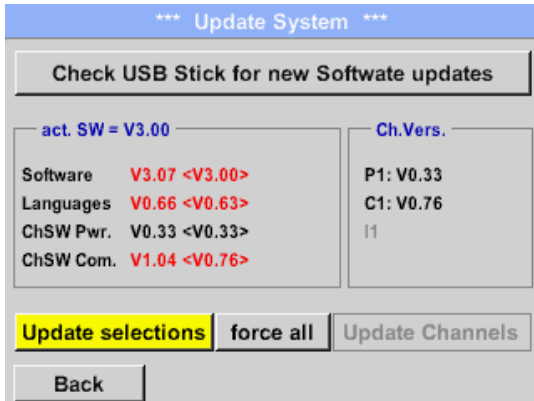

If the PI 500 is correctly connected to USB, and new version available it will displayed.

Right aside it shows the current (old) and another (new) available versions

Ist das PI 500 korrekt mit dem USB-Stick

Main menu → Settings → Device settings → Update System → Update channels

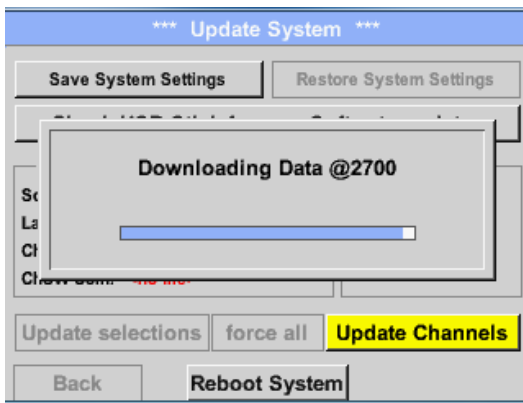

Update for the available *channels* of the PI 500.

Important:

If after the channel update the *Reboot system* button appears, it has to be pushed to restart the PI 500.

Update of the channels maybe requires a repeating of this procedure with a reboot of the system. In that case after reboot of the system a popup is displayed.

System / Factory Reset

7.3.2.1.4.5 Factory Reset

Main menu → Settings → Device settings → Factory Reset → Reset to Defaults

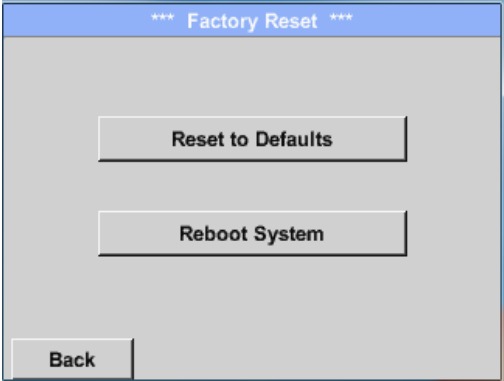

If necessary or required, by pressing the *Reboot System*-button the PI 500 could be rebooted.

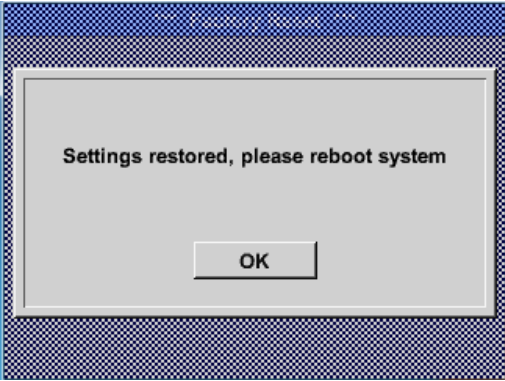
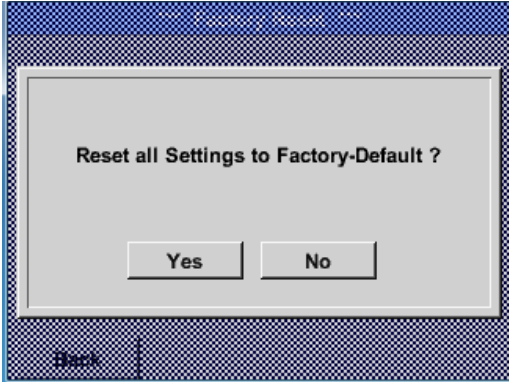

Device - Settings / calibrate touchscreen / Set backlight

7.3.2.1.4.6 Calibrate touch-screen

Main menu → Settings → Device settings → calibrate touchscreen

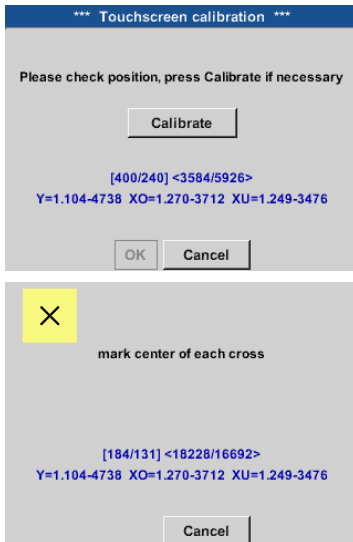

If necessary, a touch-screen recalibration can be made here. (Improved usage of touch)

Start by pressing *Calibrate* where a calibration cross successively appears successively the top left, bottom right, bottom left, top right and in the middle.

These positions have consecutively confirmed in the cross center (pressed).

When the calibration is completed positively a message is displayed "*Calibration successful*" and have to be confirmed *OK*.

Is this not the case, so you can repeat the calibration with the help of the *Cancel* and *Calibrate* buttons.

7.3.2.1.5 Set backlight

Main menu → Settings → Brightness

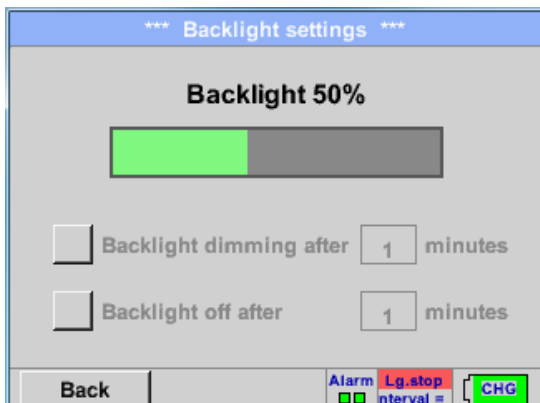

Here you adjust the desired *Backlight* (15-100%) of the display directly.

E.g. *Backlight* to 50 %

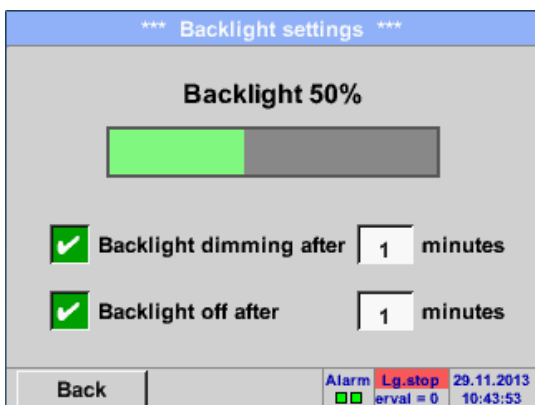

With the help of the *Backlight dimming after* button, after a definable time interval (here after 15 minutes), the *Backlight* can be reduced to the minimum.

In addition, for a longer battery runtime, the backlight could be switched off completely after the defined time (here 1 minutes) by pressing *backlight off after* button.

As soon as the dimmed screen is operated again, the *Backlight* is committed automatically on the last set value before dimming.

Remark:

At the first touch, the *Backlight* in our example is reset to 50%, after that a "normal" function operation is possible.

Important:

If the *Backlight dimming after* button is not activated, then the *Backlight* stays permanently on, in the currently set brightness.

Device - Settings / Cleaning and System Status

7.3.2.1.6 Cleaning

Main menu → Settings → Cleaning



This function can be used for cleaning the touch panel during running measurements.

If one minute is not enough time to clean, the process can be repeated at any time.

Is the cleaning faster finished, then you can push the "to abort press long" button (for one or two seconds) to cancel.

7.3.2.1.7 System-Status

Main menu → Settings → System-Status

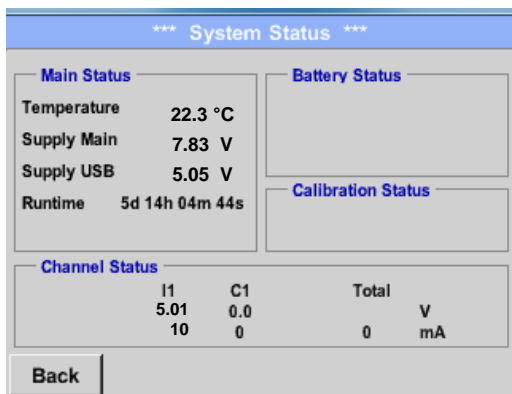

The function **System Status** offers an overview, fitting voltages and currents on the individual and the entire channel, as well as the power supply of the power supply unit.

By the **Runtime**, you always know how long the PI 500 was in total in operation

7.3.2.1.8 About PI 500

Main menu → Settings → About DP 510



Brief description of the **Hardware** and **Software Version**, as well as the **Serial Number** of the PI 500.

Under options, you can buy two additional, different functions, if you have not done this by ordering.

Chart

7.3.2.2 Chart

Main menu → Chart

Attention:

In the **Chart** there can be represented only records that have already finished!

Current records can be seen in *Chart/Real time values*.

(See chapter 7.3.2.3 Chart/real time values)

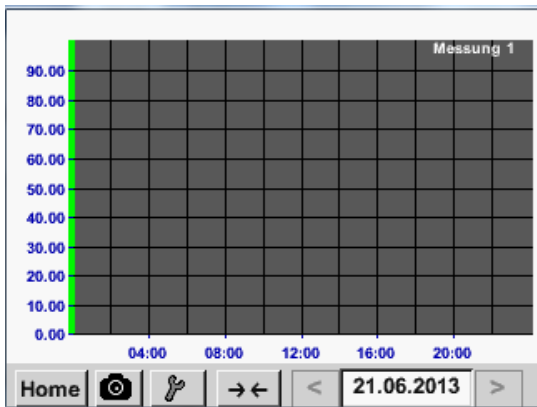

Running measurement, there are no values represented!

Zoom and scroll options in the time domain of the *Chart*:

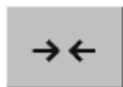

Maximal an entire day can be represented (24h).



The smallest possible range is represented, depending on the time interval of the recording.

Additional zooming and scrolling options in *Chart* and *Chart/Real time values*

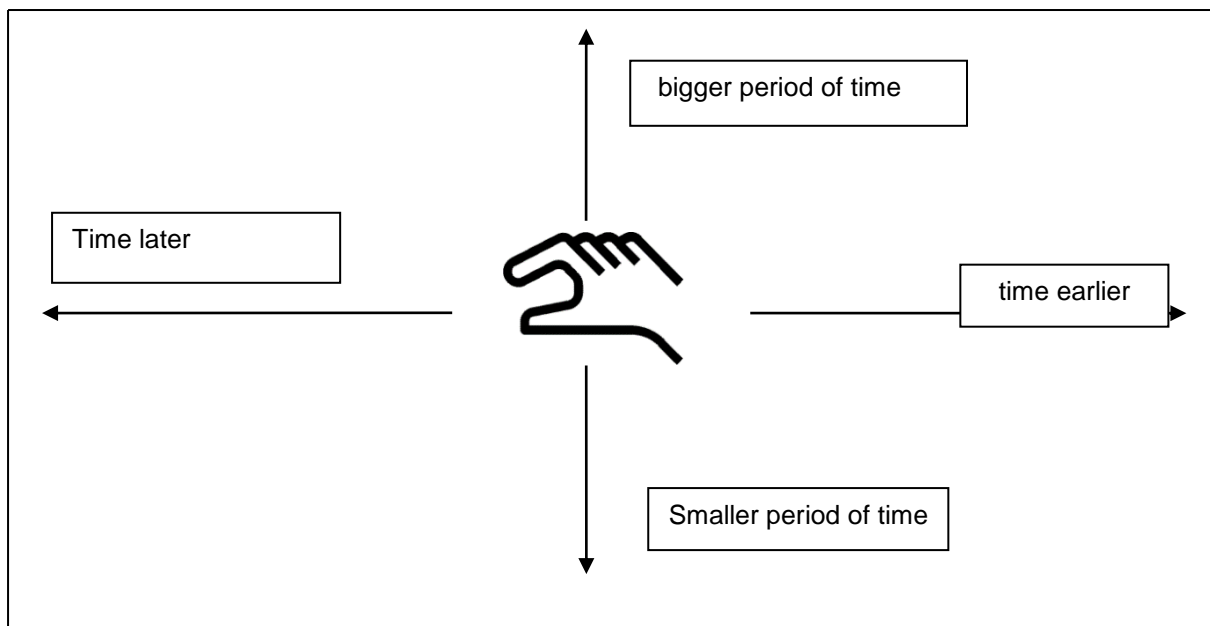

Chart

Main menu → Chart → Date description field



By pushing the **date** description field (center bottom) the calendar, from which the appropriate date can be selected conveniently, appears.



Stored measuring data can be select here by **time** (**START** and **STOP**), **Comment** and **File name** (contains English date).

Main menu → Chart → Setup

In the **Setup**, you can make up to four different y-axis labels and in addition choose a **Unit**, the grid (**min**, **max**, **step**) and several channels (**Plots**) and a **Colour**.

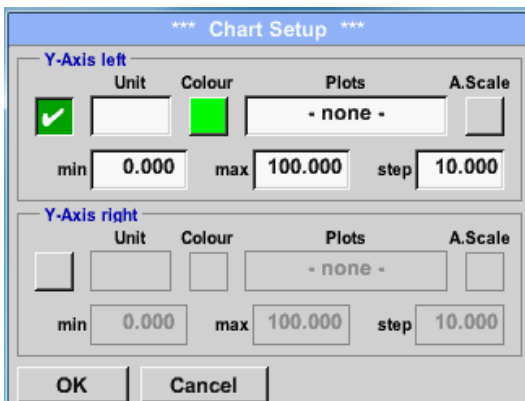

The y-axis **left** is already enabled, you can choose a **Colour** for it.

Remark:
Grid setting is already possible at this point, but later when a record is selected it is more reasonable!

Chart

Main menu → Chart → Setup → Unit description field



Select the *Unit* of the represented recording from the menu.



Main menu → Chart →

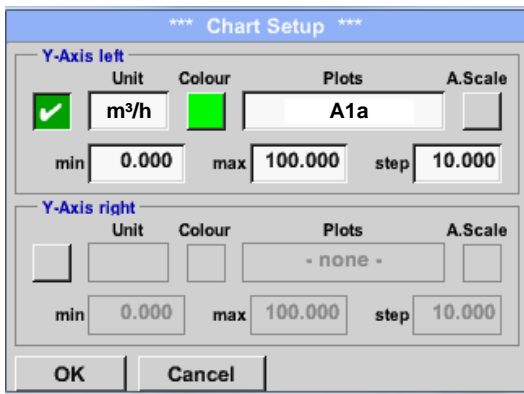

Now, the grid can be set with *min*, *max*, and *step*.
By pushing the *A.Scale*-button a calculated auto-scaling will be defined.

In the same way the remaining y-axes can be labelled!

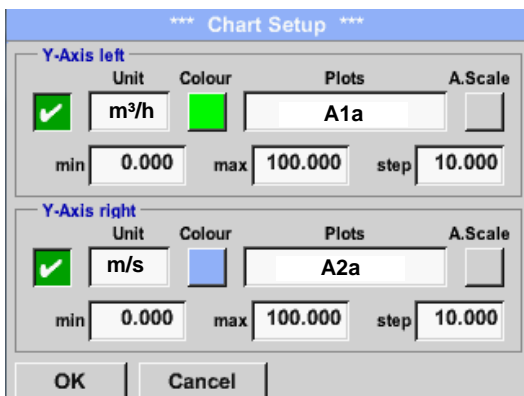

Two different grid settings with various *Units* and *Colours*.

Chart

Main menu → Chart

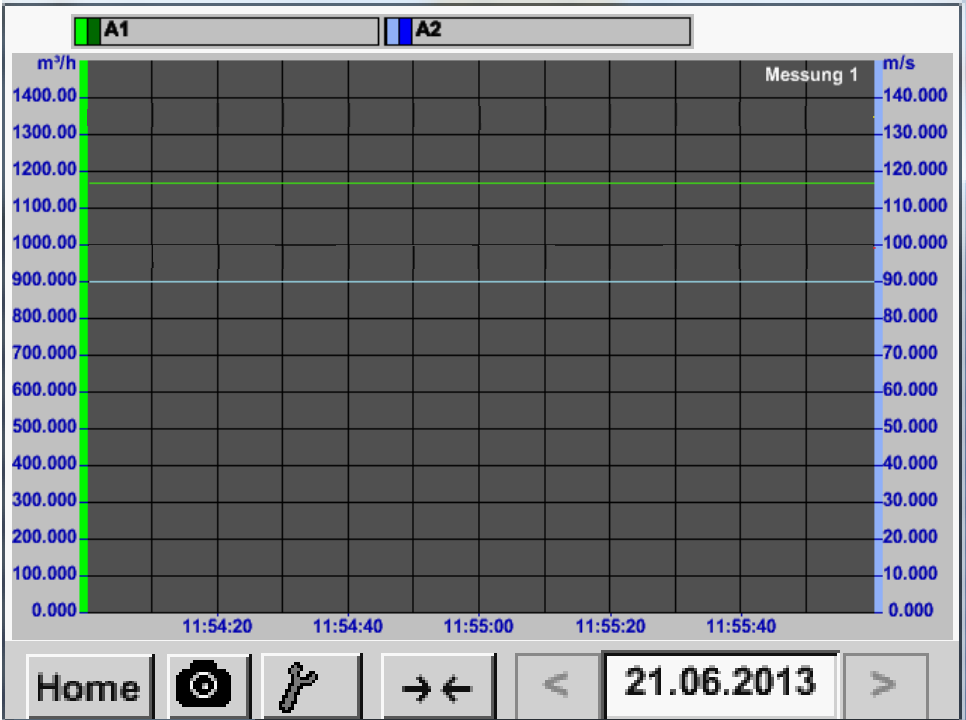
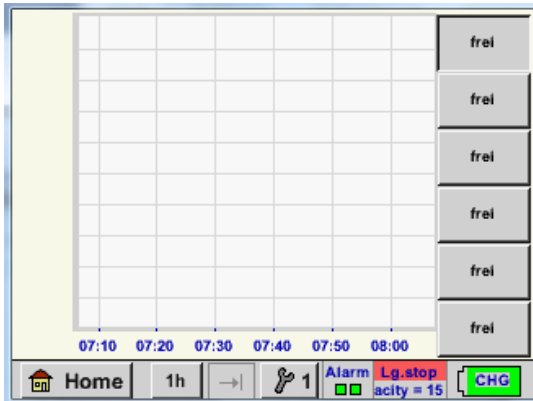

Chart / Real time values

7.3.2.3 Chart / Real time values

Main menu → Chart/Real time values



One or more channels for the recording and presentation of measured data can be selected here, such as a dew point sensor or several different sensors.

After pushing this button, currently recorded measurement data in the current time range are represented.

Quick access to predefined time periods 24 h, 8 h, 1 h, 15 min and 2 min. At the push of a button the chart for the selected time range is displayed.



Main menu → Chart/Real time values → #1- #6

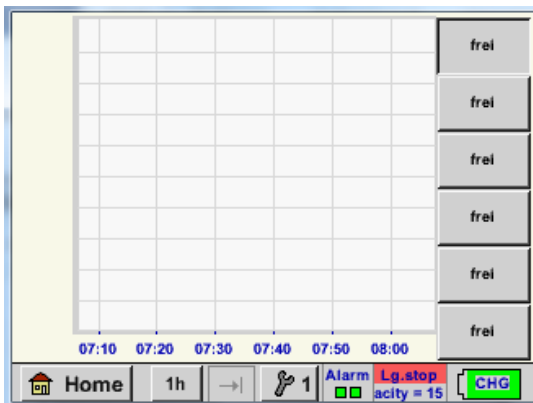

In this menu item, up to six channels can be activated at the same time and viewed in *Main → Chart/Real time values*.

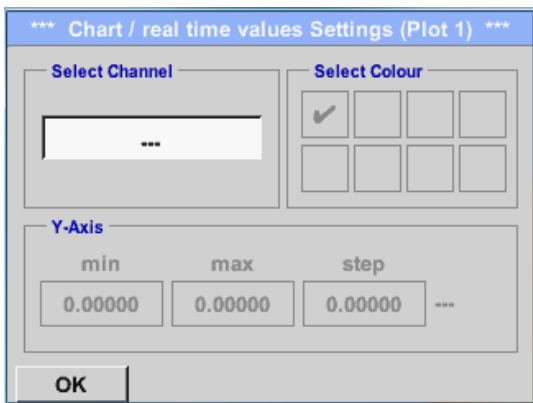

Here the channel C1 chosen.

For each channel, you can select a value to be represented in the *Chart* and one to display (*2. values*).

In addition, it can be set, like in *Main → Chart*, a *colour* and the grid (*min, max, step*) of the y-axis.

Chart / Real time values

Main menu → Chart/ Real time values

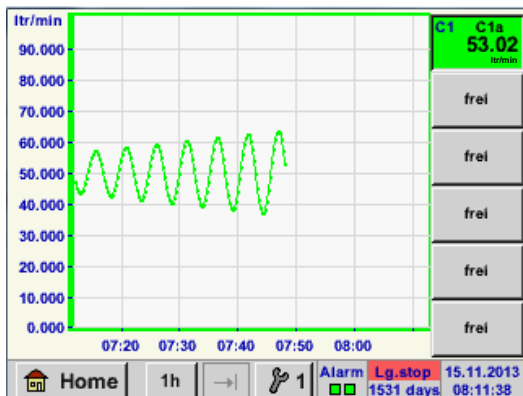

Channel C1:

Elected the flow as *Chart*

If several channels are logged, all charts will be displayed, but there is only the y-axis of the selected channel visible.

If there is no grid entered in the setup, *min* will be 0, *max* 100 and *step* 10

In the same way the remaining setups can be set!

Channels

7.3.2.4 Channels

Main menu → Channels

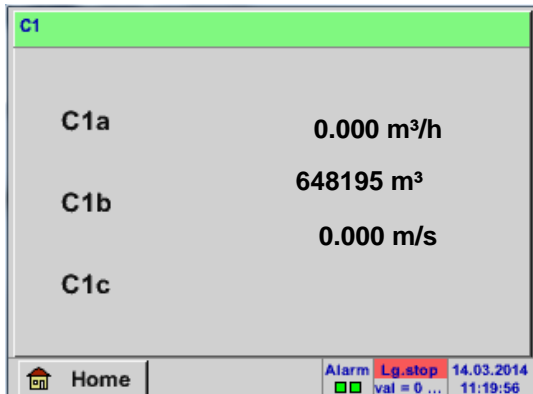

The overview of *Channels* shows the current measured values of all connected sensors.

Exceeds or falls below the set alarm limits, the respective measured value flashes yellow (*alarm 1*) or red (*alarm 2*).

Main menu → Channels → C1

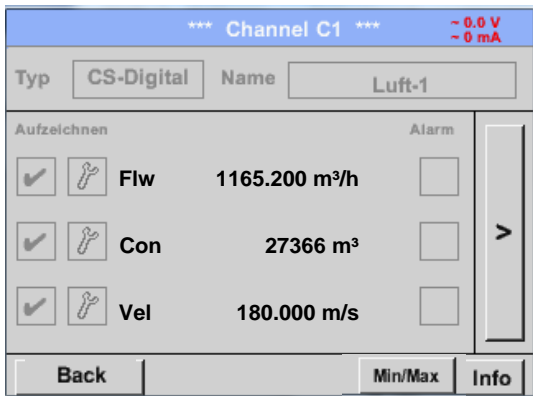

Each channel can be selected and the settings viewed and checked, but **no changes** can be made here.

Remark:
Please, make changes in the *Settings!*

7.3.2.4.1 Min/Max Function

This feature allows to read out the minimum or maximum values of the current measurement for each connected sensor. Start of recording is immediately after setting of the sensor, but there is always the possibility to reset the Min and Max values.

Main menu → Channels → I1 → **Min/Max**

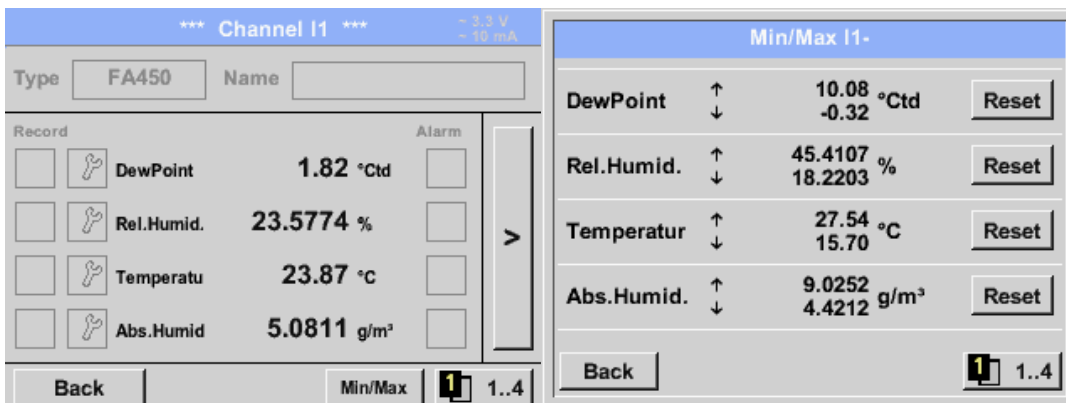

↑ = Max-Wert ↓ = Min-Wert

Channels

Main menu → Channels → C1 → **Min/Max** → Dew point **Reset**

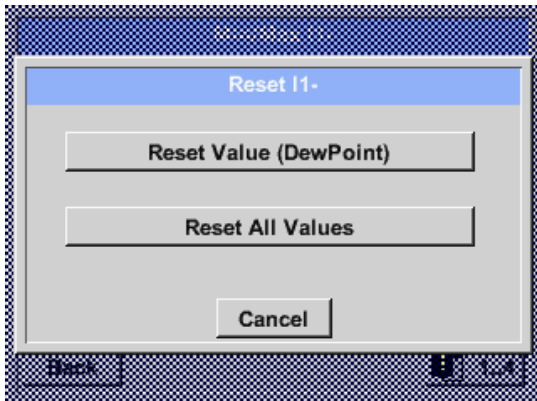

It is possible to reset a single measurement value, here it is the dew point or if needed to reset all minimum and maximum values of the sensor.

For resetting the single value the *Reset Value* –Button for all Min/Max-Values the *Reset All Values* –Button has to be pressed.

Real time values

7.3.2.5 Real time values

Main menu → Real time values

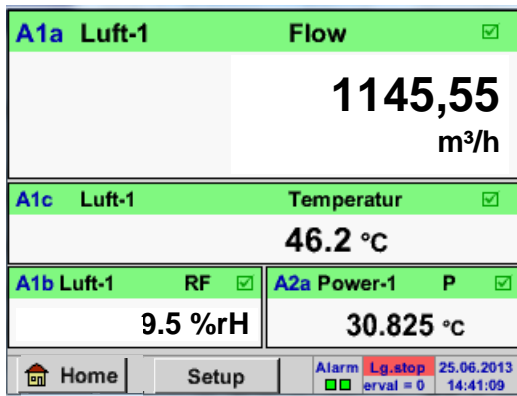

The view *Real time values* allows displaying of 1 to 5 free definable measurement values.

By exceeding the upper- or lower alarm levels the respective measurement value flashes yellow for *Alarm-1* or red for *Alarm-2*.

Remark:
Changes for display settings have to be done in the *Setup* menu!

Main menu → Real time values → Setup → next Layout

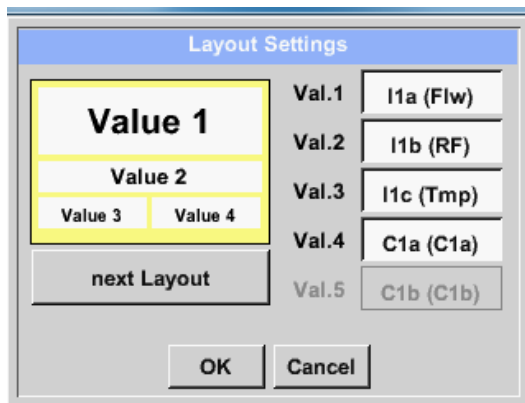

Here, by pressing *next Layout*-button it is possible to select the wanted layout.

You can choose between 6 different layouts showing 1-5 measurements. see below.

The values to be displayed could be selected in the *Val.1 to Val.5* description fields.

Different variants:

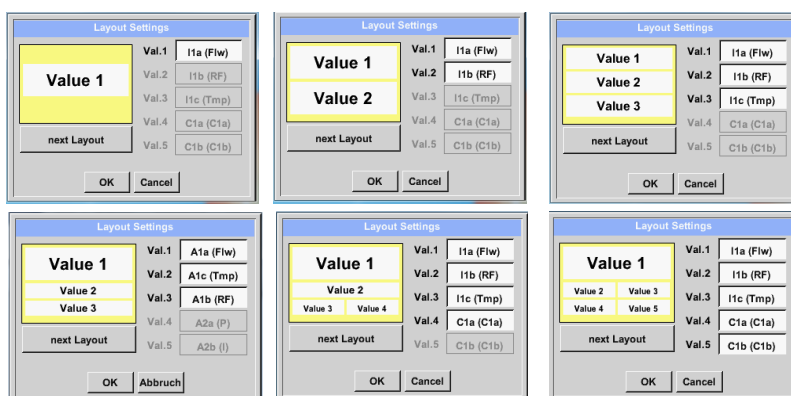

Alarm overview

7.3.2.6 Alarm overview

Main menu → Alarm-Overview

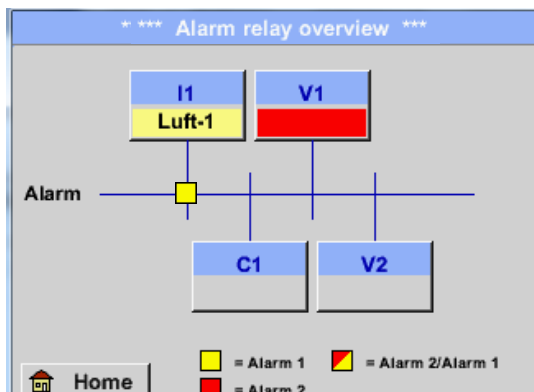

In the Alarm overview, you can immediately see whether there is an *alarm 1* or *alarm 2*. You can see also in other menu items:
Main → *Real time values* and
Main → *Settings* → *Sensor settings*
The channel name will appear yellow inverts (*alarm 1*) or inverse red (*alarm 2*).
In addition, you can see which popup had been set for the channel as the *alarm 1* or *alarm 2*.

Here *Alarm-1* for Channel I1!

Main menu → Alarm-Overview → C1

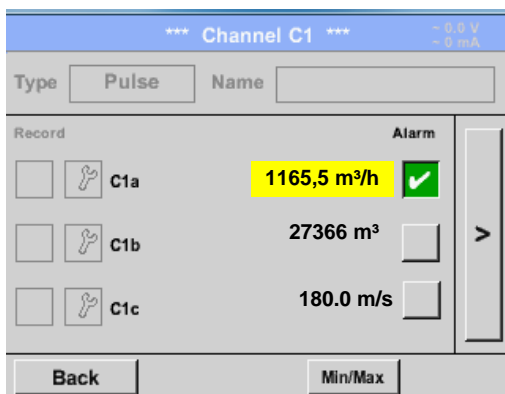

Like in *Main* → *Real time values*, individual channels can be selected here, to detect which and how much the value has exceeded or below the alarm range.

Remark:

The alarm parameters can be set and/or modified here.

8 Export /Import

Recorded data can be transferred to a USB stick, by using *Export/ Import*.

Main menu → Export / Import

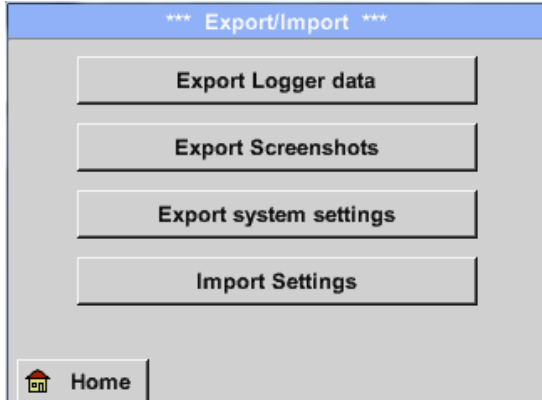

With *Export Logger data*, *Export Screenshots* and *Export system settings* the recorded measurement data, screenshots and saved settings can be transferred to a USB stick.

With *Import Settings* saved system settings could be imported from USB stick or SD card.

8.1 Export Logger data

Main menu → Export data → Export Logger data



Use the *Change* buttons to adjust a period between *start* and *end*. Stored measurement data in this period are exported.

Main menu → Export data → Export Logger data → Change

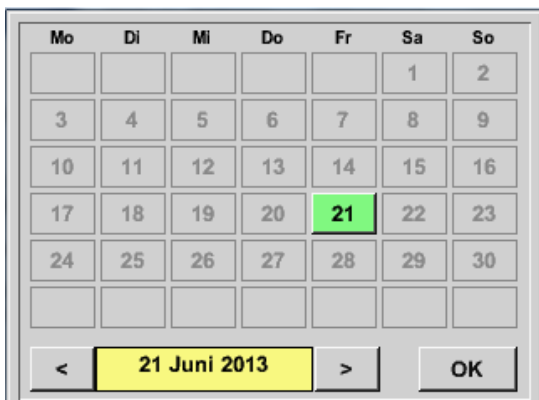

The selected date is always green, and the date numbers of the Sundays are red, like in the calendar.

On days, where measurement data were recorded, the date numbers are optical highlighted.

Export / Import

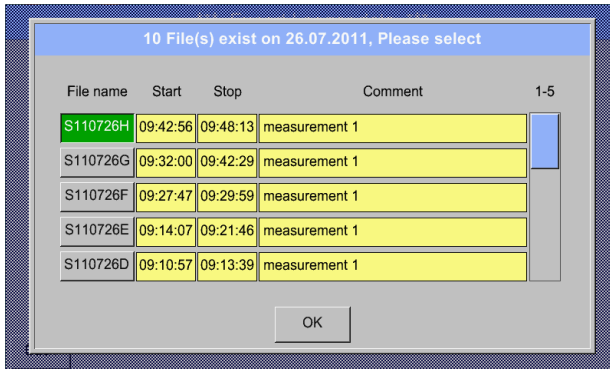

If there have been recorded several measurements on the same date, they appear after the date selection with **OK**.

Now a recording can be selected comfortable.

Main menu → Export data → Export Logger data → export

The measurement data of the selected period are exported to a USB stick.

Main menu → Export data → Export system settings

By using *Export system settings*, all existing sensor settings can be exported to a USB stick.

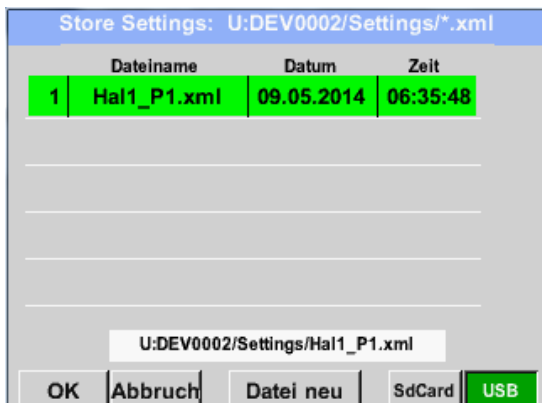

All already saved system settings will be displayed, depending on the location USB Stick or SD-Card..

Location/ path is : DEV0002/Settings

In case an existing file will be selected, the content will be overwritten with the new settings after confirming with **OK**.

New File storage:

Select the location for storing by pressing the button **USB** or **SDCard**.

By choosing button **new file** a menu for inserting/defining the filename appears.

The file name length is limited **to 8 chars**.

File save/confirm with: **OK → OK**



8.2 Export System Settings

Using this function, all existing device- and sensor settings can be exported to a USB stick or SD-card. All sensor settings including recording-, alarm-, measurement resolution-, graphics-, current values- and naming-definitions are taken over.

Main menu → Export/Import → Export system settings

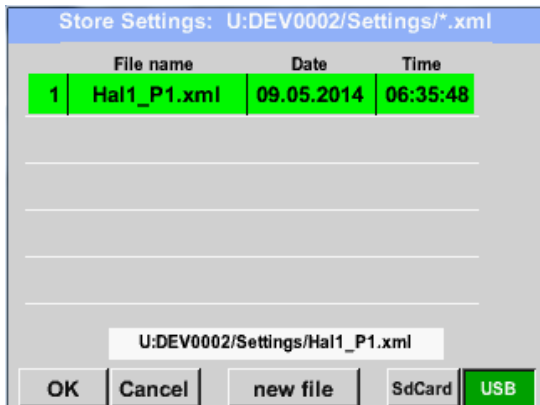

All already saved system settings will be displayed, depending on the location USB Stick or SD-Card...

Location/ path is: DEV0002/Settings

In case an existing file will be selected the content will be overwritten with the new settings after confirming with **OK**.

New File storage:

Select the location for storing by pressing the button **USB** or **SDCard**.

By choosing button **new file** a menu for inserting/defining the filename appears.

The file name length is limited **to 8 chars**.

File save/confirm with: **OK → OK**

8.3 Import System Settings

Using this function, stored system settings can be read back again.
All sensor settings including recording-, alarm-, measurement resolution-, graphics-, current values- and naming-definitions are taken over.

Main menu → Export/Import → Import system settings

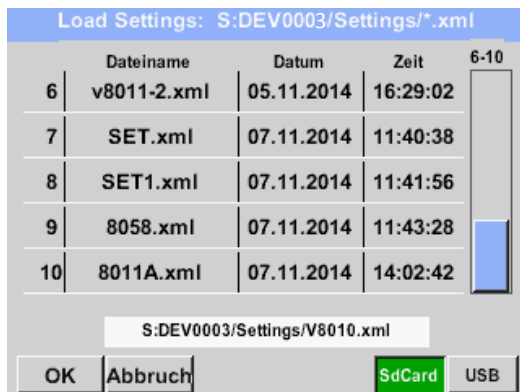

	Dateiname	Datum	Zeit	6-10
6	v8011-2.xml	05.11.2014	16:29:02	
7	SET.xml	07.11.2014	11:40:38	
8	SET1.xml	07.11.2014	11:41:56	
9	8058.xml	07.11.2014	11:43:28	
10	8011A.xml	07.11.2014	14:02:42	

S.DEV0003/Settings/V8010.xml

OK Abbruch SdCard USB



Depending on the selected location, USB stick or internal SD-card, all already stored settings will be listed.

Selection of storage location by pressing button **USB** or **SdCard**

The selected file be imported after confirming with **OK**.

To avoid any unwanted overriding's of the actual device settings it is an additional confirmation required

After importing of the new settings a reboot is required too.

For the complete takeover of the new sensor settings, they have to be activated for channel C1.

Main menu → Settings → Sensor Settings → Channel C1

9 Virtual Channels (optional)

The option „Virtual Channels“ offers 4 additional channels (no HW Channels) where it is possible to display calculations of each single HW-Channel, virtual channels and free defined constants as well. For each „Virtual Channel“ are 8 calculations each with of 3 operands and 2 operations possible.

Possible cases are calculation of:

- Specific performance of a compressor(s)
- Complete consumption of a compressor(or the sum of several compressors)
- Energycost etc.

9.1 Option „Virtual Channels“ activation

After purchasing of the option „Virtual Channels“ the functionality have to be activated first.

Main menu → Settings → About PI 500

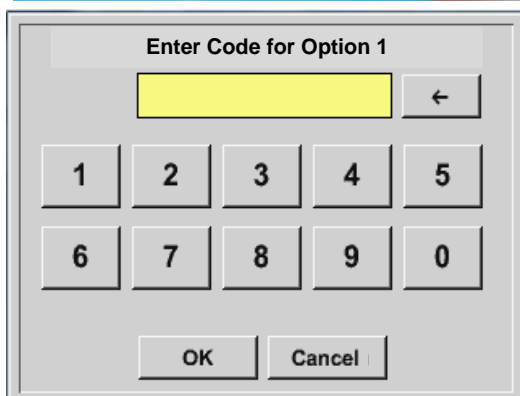

Please push the button Buy for „Virtual Channels“ and you will requested to insert the key-code received

Please enter the Key-Code in the text-field and activate the option by pushing the button **OK**

Virtual Channels

9.2 Virtual Channels Settings

Main menu → Settings → Sensor Settings → Virtual Channels

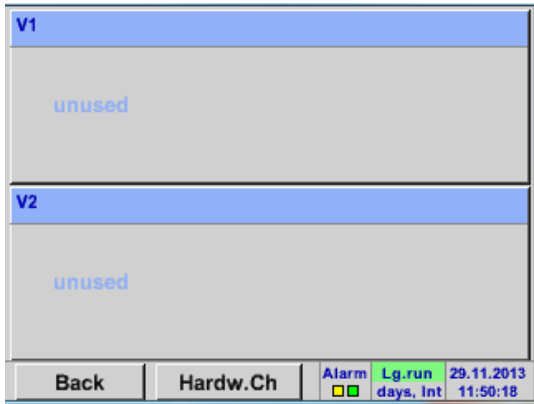

After pushing the button „*Virtual Channels*“ in the Sensor Settings menu an overview with the 4 available “*Virtual Channels*” is displayed.

Remark:
By default, all channels are without settings.

9.2.1 Selection of Sensor-type

Main menu → Settings → Sensor Settings → Virtual Channels → V1

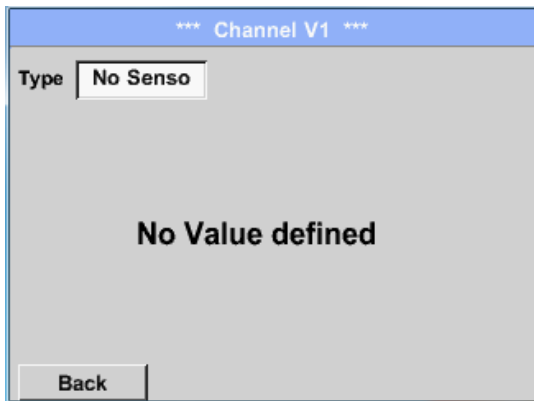

By pushing the description field *Type No Sensor* the list of sensor types appears (see next step).

Main menu → Settings → Sensor Settings → Virtual Channels → V1 → Type description field

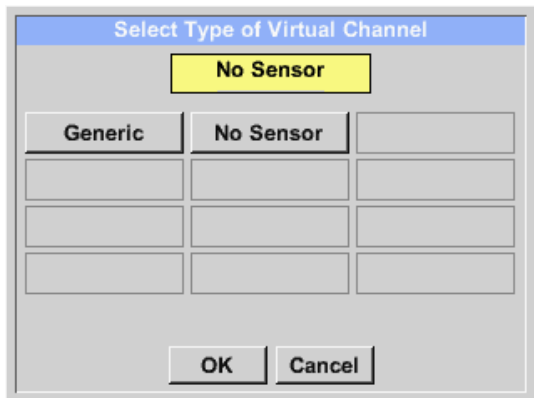

If still no sensor has been configured, the *Type No Sensor* appears.

By pushing the button **Generic** the virtual channel is selected.
Pushing the button **No Sensor** will reset the virtual channel.

Confirmation of selection is done by pressing the button **OK**.

Virtual Channels

Main menu → Settings → Sensor Settings → Virtual Channels → V1 → Name description field

By pushing the Text field *Name* a Sensor name could be inserted.

9.2.2 Configuration of each single virtual value

Each virtual channel includes 8 individual calculated values where every value has to be activated separately.

9.2.3 Activation of a single virtual value

Main menu → Settings → Sensor Settings → Virtual Channels → V1 → arrow right (2.page) → V1a → Use

Every virtual value has to be activated by selecting the respective *Value-Button* e.g. *V1a* and pushing of the *Use Button*.

9.2.4 Definition of Operands

Main menu → Settings → Sensor Settings → Virtual Channels → V1 → arrow right (2.page) → 1stOperand

By accessing the text field *1st Operand* The list with all channels (HW and virtual channels) and const. Value appears.

Virtual Channels

Main menu → Settings → Sensor Settings → Virtual Channels → V1 → arrow right (2.page) → 1stOperand → C1

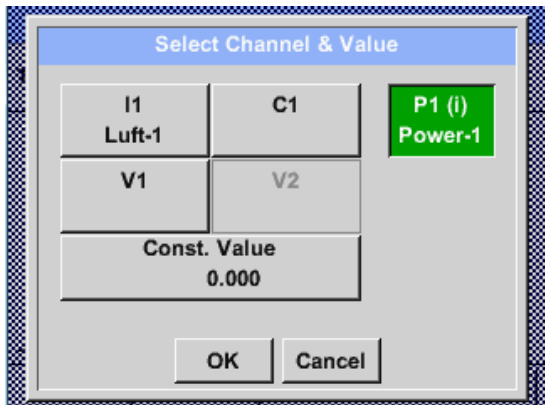

By pressing a button either for HW-, virtual channel or const. Value e.g. **C1** a list of all available measurement channels or measurement values will appear.

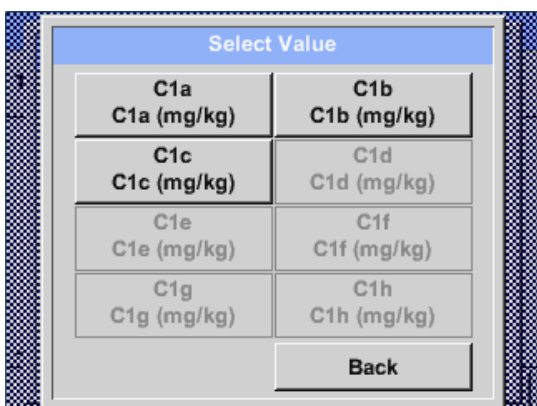

Pressing the respective channel button e.g. **C1b** will select the measurement channel

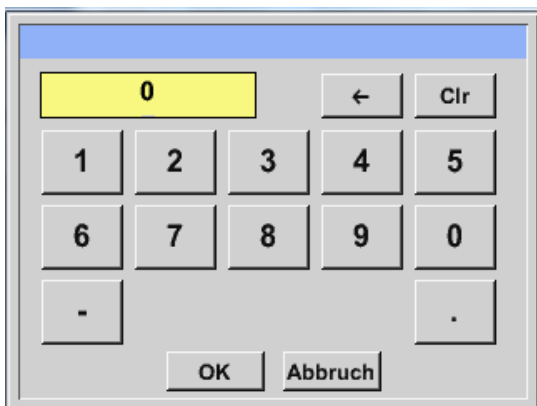

Pressing the button **const. Value** requests the input of the **const. Value** into the text field.

With button **OK** the value will validated

With the buttons **←** and **Clr** it is possible to correct the input.

Button **←** deletes the last figure

Button **Clr** clears the whole field

This approach is analogous to the other operands. (1st Operand, 2nd Operand and 3rd Operand).

Virtual Channels

9.2.5 Definition of Operations

Main menu → Settings → Sensor Settings → Virtual Channels → V1 → arrow right (2.page) → 1st Operation

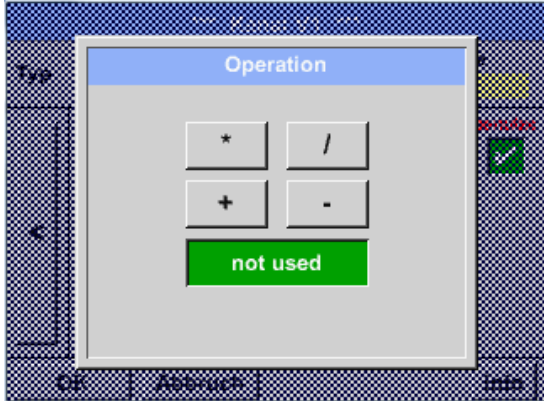

By accessing the text field *1st Operation* the list with all available operands appears.

Selecting and validation of the operand by pressing the respective operand.

Pressing of the button *not used* deactivates the operation of the dedicated operand.

This approach is analogous for both operations (1st Operation and 2nd Operation)

9.2.6 Definition of Unit

Main menu → Settings → Sensor Settings → Virtual Channels → V1 → arrow right (2.page) → Unit

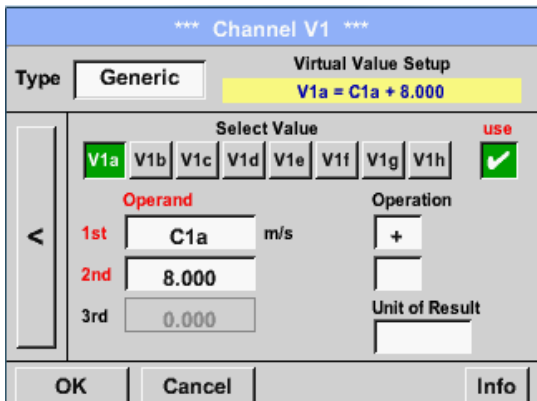

By accessing the text field *Unit of Result* the list with all available units appears

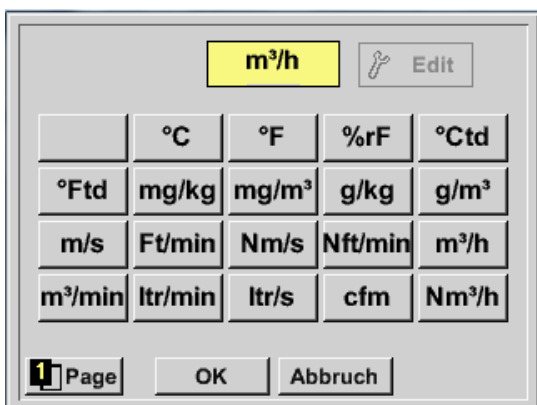

Please select the unit by pressing the respective button e.g. *m³/h*.
For validation of the unit, please push the button *OK*.
To move through the list please press the button *Page*.
In case the unit is **not** available, it is possible to create a user defined unit.
Therefore please select one of the *User_X* buttons.

Virtual Channels

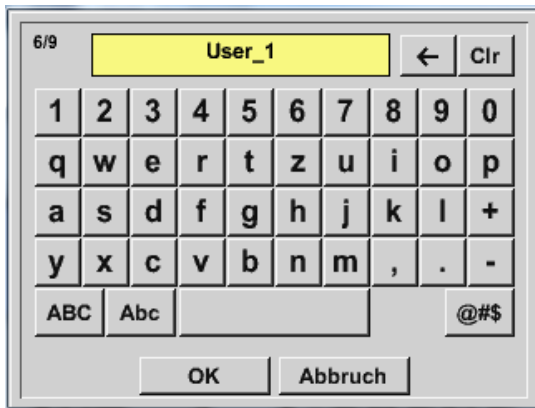

By pressing the button *Edit* you enter the menu for inserting the new Unit.

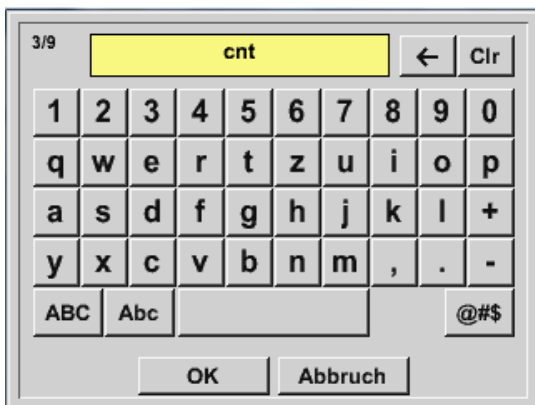

Then define the unit and confirm it with the button *OK*.

With the buttons *←* and *Clr* it is possible to correct the input.

Button *←* deletes the last figure
Button *Clr* clears the whole field

Important

Each calculation allows you the use of maximum 3 operands and 2 operations.

The calculation is then based on following formula:

Example: $V1a = (1st\ Operand\ 1st\ operation\ 2nd\ Operand)\ 2nd\ operation\ 3rd\ Operand$
 $V1a = (A1c - A2a) * 4.6$

Virtual Channels

9.2.7 Value name, resolution of decimal places and recording of values

Main menu → Settings → Sensor Settings → Virtual Channels → V1 → Tool-Button

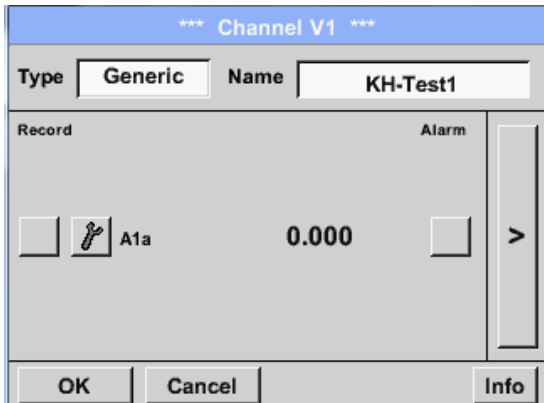

The *Resolution* of the decimal places, the *Short Name* and *Value Name* are found under the **Tool button**

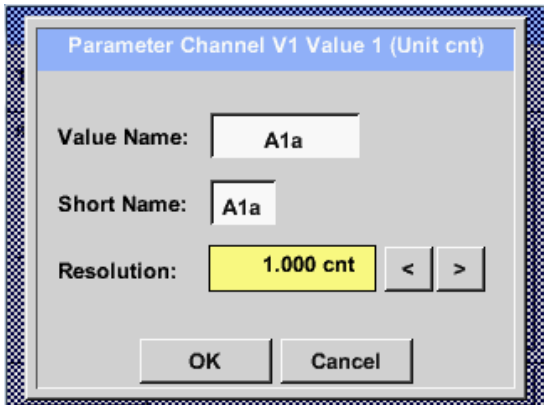

For the recorded *Value* there can be entered a *Name* with 10 characters and later in menu item *Graphics/Real time values* it is easier to identify it.
Default names are e.g. *V1a*.
V1 is the Channel name *a* is the first measuring value of channel V1, *b* is the second measuring value and *c* the third etc.
The *Resolution* of the decimal places is simply adjustable by pushing right and left

Main menu → Settings → Sensor Settings → Virtual Channels → V1 → Record Button

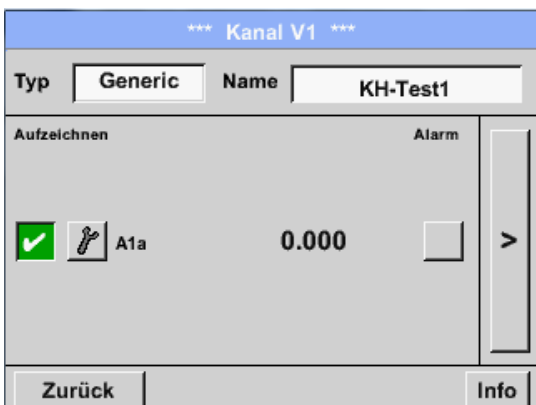

Use the *Record* buttons to select the measurement data that will be stored by **activated data logger**

Attention:

Before the selected measurement data are recorded, the data logger must be activated after the settings (See chapter [7.3.2.1.3 Logger-Settings \(Data logger\)](#)).

See also chapter [7.3.2.1.2.2 Name the measurement](#) and [7.3.2.1.2.3 Recording measurement data](#)

10 Analog Total (optional)

The Option „Analog Total“ offers the possibility of a consumption measurement also for sensors with analogue outputs e.g.: 0-1/10/30V and 0/4 – 20mA.

10.1 Option „Analog Total“ activation

After purchasing of the option „Analog Total“ the functionality has to be activated first.

Main menu → Settings → about PI 500



Please push the button *Buy* for „Analog Total“ and you will be requested to insert the key-code received

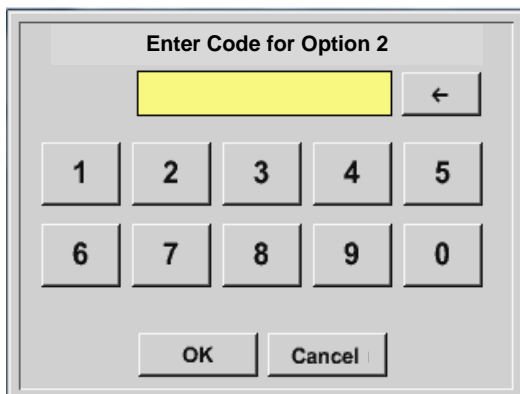

Please enter the Key-Code in the text-field and activate the option by pushing the button *OK*.

Analog Total

10.2 Selection of sensor type

See also Chapter [7.3.2.1.2.8 Configuration of analogue sensors](#)

Main menu → Settings → Sensor Settings → C1

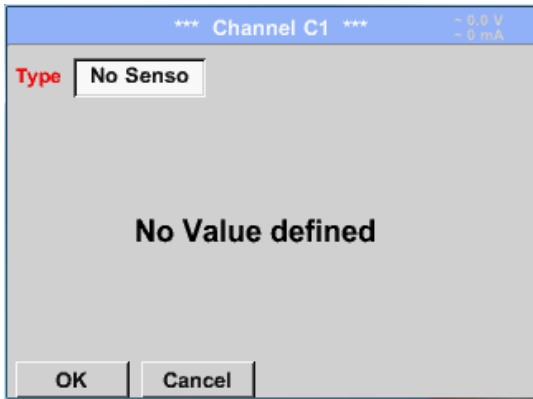

If still no sensor has been configured, the *Type No Sensor* appears.

By pushing the description field *Type No Sensor* the list of sensor types appears (see next step).

Main menu → Settings → Sensor Settings → C1 → Type description field

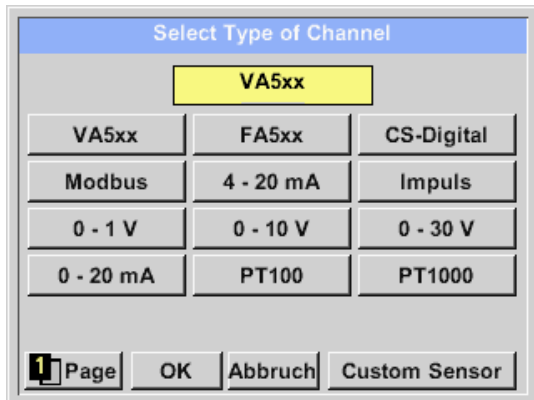

By pushing the button of the required sensor button e.g. 4 -20mA the sensor is selected. Pushing the button **No Sensor** will reset the selection.

Confirmation of selection is done by pressing the button **OK**.

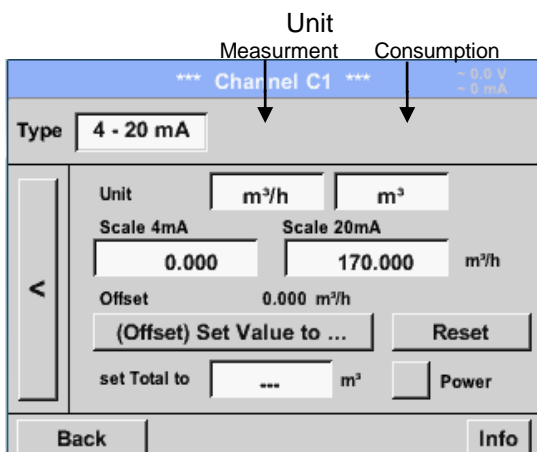

Selection of the units by pushing the text fields for the corresponding measurement and consumption units.

In addition, you can push the *scale buttons* for the min. and max. scaling values and set the measuring range.

Here we have *0 m³/h* for 4 mA and *170m³/h* for 20mA

In addition it is possible to enter a starting value for consumption entering *set Total to* field e.g. to take over value from an old counter.

Remark:

The text field „Unit-Consumption“ is only editable in case of measurement values (Units) with volume per time unit and thus also the consumption calculation.

For labelling and setting of the description fields, see also chapter [7.3.2.1.2.7 label and setting the description field](#)

Version: 12/05/2016, V1.03

KONFORMITÄTSERKLÄRUNG

DECLARATION OF CONFORMITY

Wir CS Instruments GmbH
We Am Oxe 28c, 24955 Harrislee

Erklären in alleiniger Verantwortung, dass das Produkt
Declare under our sole responsibility that the product

Handmessgerät PI 500
Hand-held instrument PI 500

den Anforderungen folgender Richtlinien entsprechen:
We hereby declare that above mentioned components comply with requirements of the following EU directives:

Elektromagnetische Verträglichkeit Electromagnetic compatibility	2014/30/EU 2014/30/EC
---	--------------------------

Angewandte harmonisierte Normen:
Harmonised standards applied:

EMV-Anforderungen EMC requirements	EN 61326-1: 2006-10 2013-07 EN 61000-3-2 : 2015-3
---------------------------------------	--

Anbringungsjahr der CE Kennzeichnung: 13
Year of first marking with CE Label: 13

Das Produkt ist mit dem abgebildeten Zeichen gekennzeichnet.
The product is labeled with the indicated mark.



Harrislee, den 19.04.2016

Wolfgang Blessing Geschäftsführer



报告编号(Report ID): H11133012221D~1

锂电池UN38.3测试报告

Lithium Battery UN38.3 Test Report

样品名称 (Sample Description)	Lithium-ion Battery 238700
委托单位 (Applicant)	Jauch Quartz GmbH-Batteries
生产单位 (Manufacturer)	Jauch Quartz GmbH-Batteries



No.: H11133012221D
Code: ssak93kqy



Pony Testing International Group

I. SAMPLE DESCRIPTION

Sample Name	Lithium-ion Battery		Battery Type	238700	
Client	Jauch Quartz GmbH-Batteries				
Manufacturer	Jauch Quartz GmbH-Batteries				
Nominal Voltage	7.2V	Rated Capacity	2600mAh	Limited Charge Voltage	8.56±0.025V
Charge Current	1250mA	Maximum Continuous Charge Current	2600mA	End Charge Current	100mA
Cut-off Voltage	5.5V	Maximum Discharge Current	5200mA	Use	---
Cells Number	2PCS	Cell Model	18650	Rated Capacity	2600mAh
Manufacturer of cell	Samsung SDI Co., Ltd				
Chemical component	Li-Ion				
Client date	2013-11-12		Finished date	2013-12-02	

II. REFERENCE METHOD

《United Nations Recommendations On The Transport Of Dangerous Goods, Manual Of Tests And Criteria》(ST/SG/AC.10/11/Rev.5/Amend.1).

III. TEST ITEM

- | | |
|------------------------|---------------------------|
| 1. Altitude simulation | 5. External short circuit |
| 2. Thermal test | 6. Impact |
| 3. Vibration | 7. Overcharge |
| 4. Shock | 8. Forced discharge |

IV. CONCLUSION

ITEM	SAMPLE NUMBER	STANDARD	CONCLUSION
Altitude simulation	N1~N4 C1~C4	UN38.3	PASS
Thermal test			PASS
Vibration			PASS
Shock			PASS
External short circuit			PASS
Impact	N9~N13		PASS
Overcharge	N5~N8 C5~C8		PASS
Forced discharge	N14~N23 C9~C18		PASS

The submitted battery and component cell were complied with the UN Manual of Tests and Criteria, Part III, sub-section 38.3.

Prepared by: *Pony Kwei Kwei*

Checked by: *chengpeng*

Approved by: *Liyao*

Approval Date: December 2, 2013



www.ponytest.com ☎Hotline 400-819-5688

Add: 北京市海淀区东升园19-3号嘉利大厦	Add: 上海市徐汇区桂平路600号25号楼4层	Add: 深圳市南山区创业路中兴工业城4层	Add: 青岛市崂山区株洲路199号4层
Tel: (010) 82618118	Tel: (021) 64891999	Tel: (0755) 26080900	Tel: (0532) 89796800
Add: 天津市南开区仕嘉路嘉苑大厦10层	Add: 宁波市江北区新海路150号二楼104室	Add: 广州市海珠区滨江路189号海珠中心2号楼7层	
Tel: (022) 27160730	Tel: (0574) 87716499	Tel: (020) 89224310	