

Instruction Manual

Digital Display DS 52

in wall housing

Order no. 0500 0008

for 0/4...20 mA sensors



Table of content

Page

Introduction	2
Safety instructions	3
Short-form instruction DS 52 with 0/4...20 mA sensors	4
Menu with all functions	8
Lock operation menu, enter code, lock alarm values	9
Calibration/adjustment	10
Warranty	10
Technical data	11
Order information	12
Notes	13
Contact	14

Introduction

Dear customer,

Thousands of customers buy our high standard products every year. There are a few good reasons for doing so:

- The cost-performance ratio - reliable quality at a fair price.
- We have the ideal solutions for your measuring tasks based on our expert experience gained over 20 years.
- Our high quality standard.
- Of course, our instruments carry the CE symbol required by the EU.
- We issue calibration certificates and hold seminars.
- Also after the purchase we do not leave you out in the cold - we offer a good after sales service.

Our service grants you a fast help.



Measuring instrument conforms with **DIN EN 61326**

1. Safety instructions

Observe measuring ranges of the sensors!

Observe the admissible storage and transportation temperature as well as the permitted operating temperature (e. g. protect the instrument from direct insolation)

Adjustments and calibrations should only be carried out by qualified employees from the measurement and control technology branch.

We offer you to take back the instruments DS 52, which you would like to dispose of.

The manufacturer cannot be held liable for any damage which occurs as a result of non-observance or non-compliance with these instructions. Should the device be tampered with in any matter other than a procedure which is described and specified in the manual, the warranty is cancelled and the manufacturer is exempt from liability.

CS Instruments GmbH offers no guarantee for the suitability for any other purpose and is not liable for errors which may have slipped into this operation manual. CS Instruments GmbH is also not liable for consequential damage resulting from the delivery, capability or use of this device.

Initiation (electrical connection)

When operating electrical instruments it is unavoidable that certain components are energised dangerously. Work at electrical installations or equipment is only allowed to be carried out by electrical technicians or instructed staff under the guidance and supervision of an electrical technician according to the electrical regulations.

Warning

Any non-observance of the warning notes may cause grievous bodily harm or property damages. Qualified staff has to be well familiar with all warnings according to this instruction manual. The correct and safe operation is subject to a proper transport, professional installation and accurate initiation. The following notes on safety are applied in order to stress safety relevant procedures in this instruction manual - every note is marked by a corresponding icon.



This symbol means: **Note!**

"**Note**" marks activities or procedures which have a fundamental influence on correct operation. Any non-observance may possibly lead to subsequent damages.



This symbol means: **Warning!**

"**Warning**" indicates activities or procedures which may lead to a safety risk for persons and property damages in case of non-observance.

2. Short-form instruction DS 52 with 0/4...20 mA sensors

Power supply and alarm connection:



Attention!
Mains voltage!

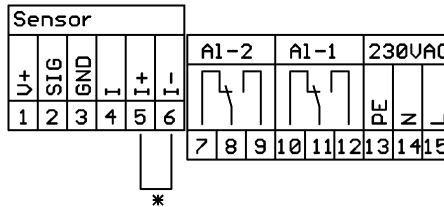

AC Power
230 VAC
50 Hz

NC und COM are closed
in case of:
- alarm exceeding
- voltage drop
- sensor break

2.1 Connection of CS Instruments sensors

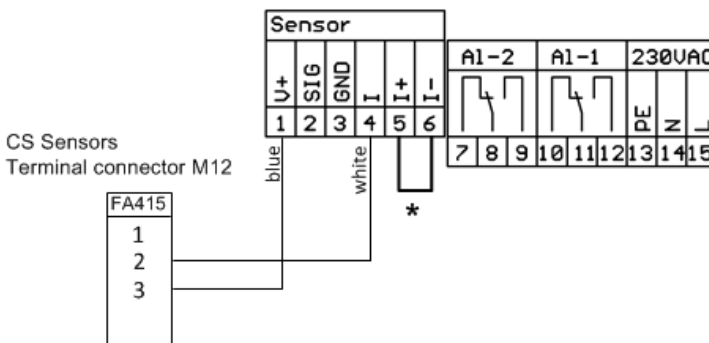
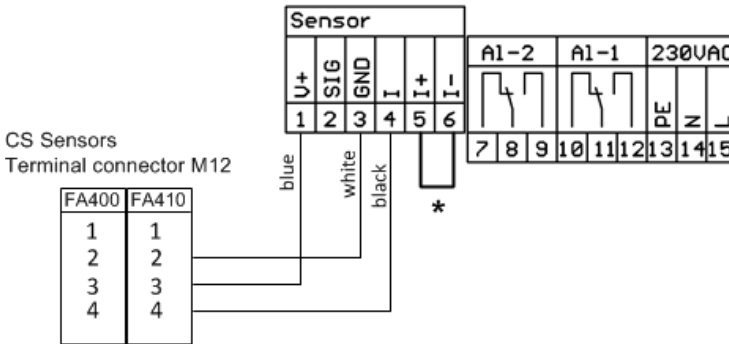

* A bridge circuit is inserted ex factory . For signal transfer please remove the bridge circuit and attach the connection cables. Attention: Current loop has to be closed!

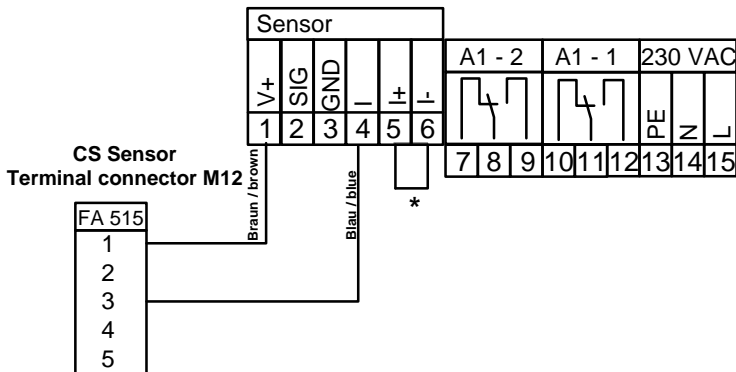
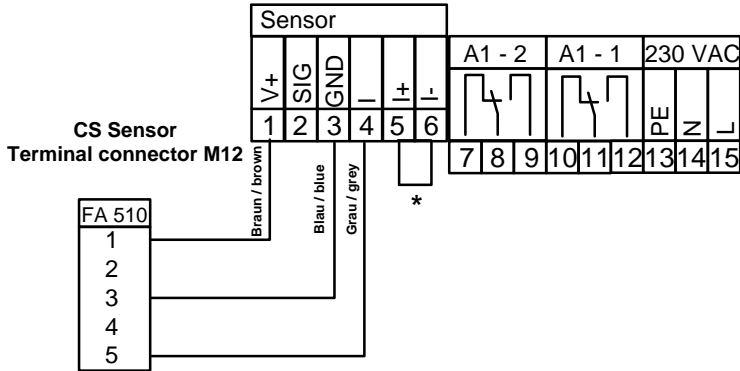

* A bridge circuit is inserted ex factory . For signal transfer please remove the bridge circuit and attach the connection cables. Attention: Current loop has to be closed!

2.2 Connection of third party sensors

DS 52 has one analogue sensor input for connection of sensors with 0/4...20 mA signal. The sensor input is configured on our premises (according to the customers specification in the order).

Sensors with 0/4...20 mA-current signal are connected as follows:

V+ max:
24 VDC
100 mA

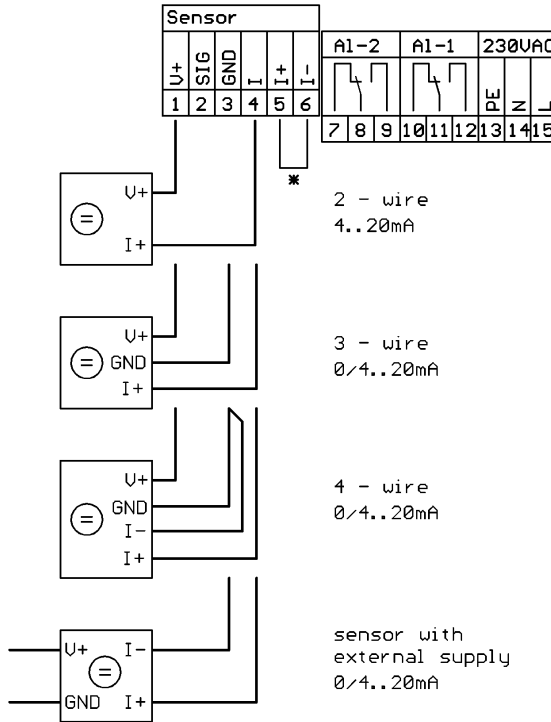

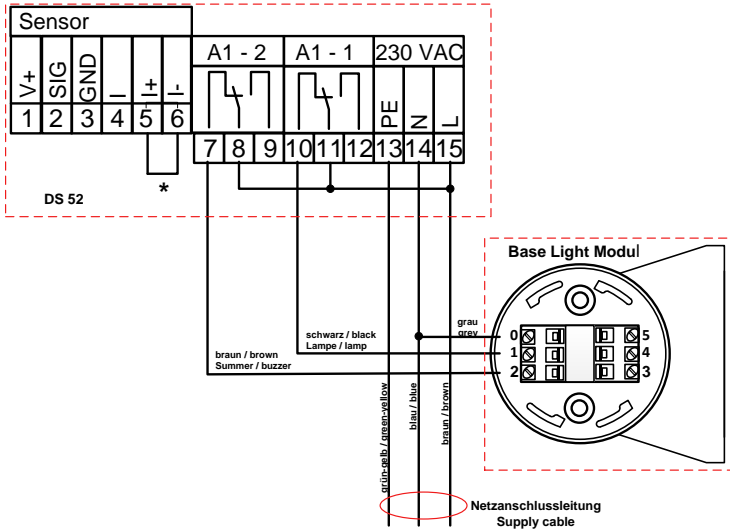

* A bridge circuit is inserted ex factory . For signal transfer please remove the bridge circuit and attach the connection cables. Attention: Current loop has to be closed!

2.3 Connection option alarm unit



3. Menu with all functions

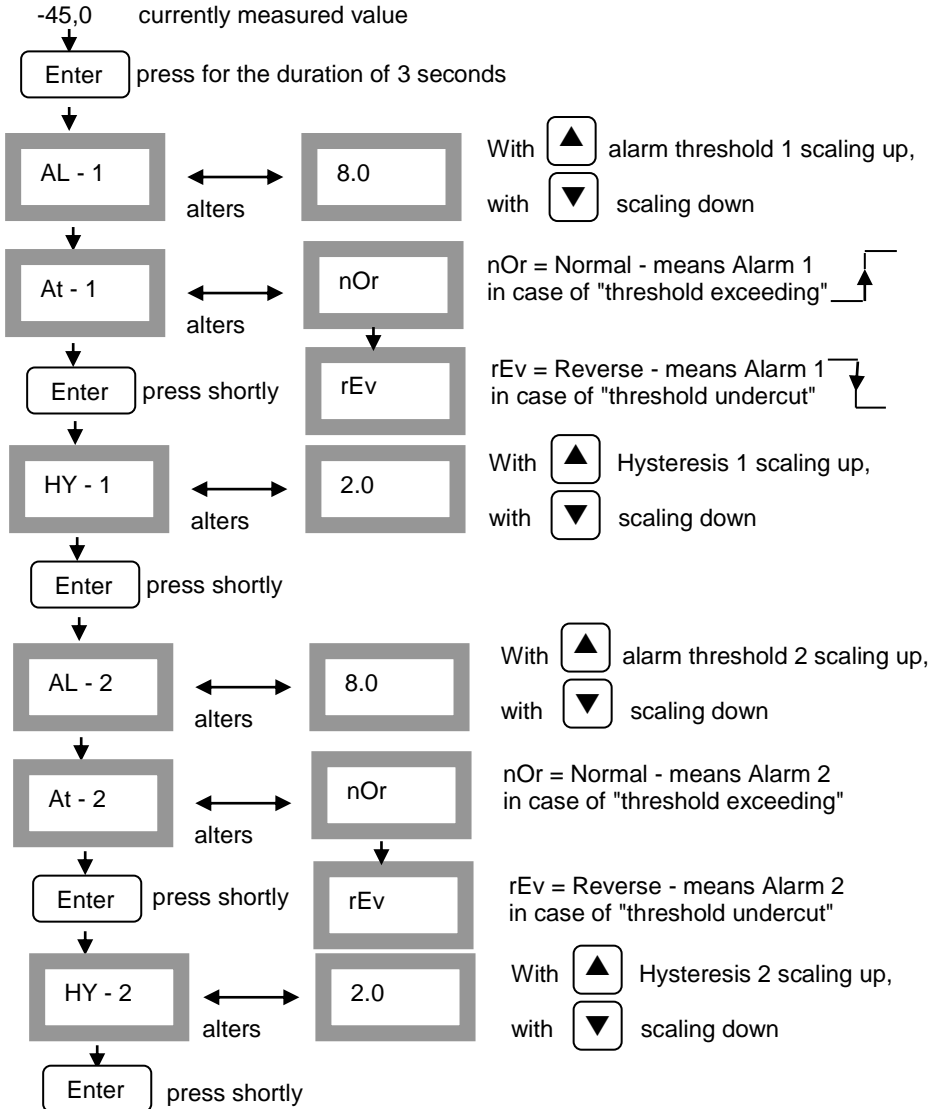

The operation is effected via 4 keys:  and  as well as ,
in order to access the menu/to confirm selection and 

The operation in detail:



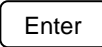

4. Lock operation menu/alarm values - enter code - scale sensor signal

The instruments operation (adjustment of alarm values) can be locked by means of a code.

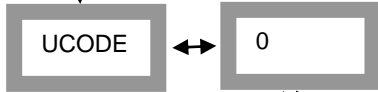
 +  +  pressed at the same time for 3 seconds



Factory setting: UCode = 0.
The menu points are not protected by a code and can be used by everybody.

With  and  any code from 0 to 999 can be set. This locks the menu point "Set alarm thresholds", they only can be changed if the correct code is entered at the beginning of the menu.* If the menu should not be locked please enter Ucode = 0 resp. keep the factory settings without any changes. If the entered code has been forgotten please enter the code = 978 then the lastly entered code will occur.

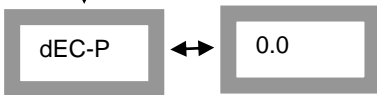

 Code was stored



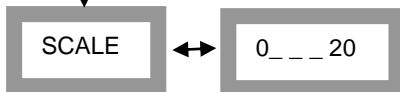

Set decimal point with  and  (0...0.000)

 Decimal point setting was stored



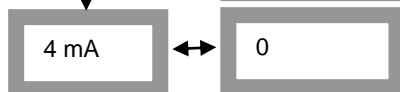

Choose with  and  whether you want to connect a sensor with 0...20 mA signal or with 4...20 mA signal.



With  and  you can set the lower scaling value (4 mA resp. 0 mA) of your sensor



With  and  you set the upper scaling value (20 mA) of your sensor

 Scaling for 4 and 20 mA was stored

In order to access the measuring menu please press the ENTER key for 3 seconds. For further operation steps please see point 3. If you have entered a code please use this code in order to set the alarm values (see point 3. "Menu with all functions", page 5).

5. Calibration/adjustment

At CS Instruments

According to DIN ISO certification of the measuring instruments we recommend to calibrate and if applicable to adjust the instruments regularly at the manufacturer. The calibration intervals should comply with your internal specification. According to DIN ISO we recommend a calibration interval of one year for the instrument DS 52 including probes.

6. Warranty

If you have reason for complaint we will of course repair any faults free of charge if it can be proven that they are manufacturing faults. The fault should be reported immediately after it has been found and within the warranty time guaranteed by us. Excluded from this warranty is damage caused by improper use and non adherence to the instruction manual.

The warranty is also cancelled once the instrument has been opened - as far as this has not been mentioned in the instruction manual for maintenance purposes - or if the serial number in the instrument has been changed, damaged or removed.

The warranty time for DS 52 is 12 months, the warranty time of the accessories is 6 months. Warranty services do not extend the warranty time.

If in addition to the warranty service necessary repairs, adjustments or similar are carried out the warranty services are free of charge but there is a charge for other services such as transport and packaging costs. Other claims, especially those for damage occurring outside the instrument, are not included unless responsibility is legally binding.

After sales service after the warranty time has elapsed

We are of course there for you even after the warranty time has elapsed. In case of malfunctions please send us the instrument with a short-form description of the fault. Please do not forget to indicate your telephone number so that we can call you in case of any questions.

7. Technical data

Housing dimensions	118 mm x 92 mm x 133 mm
Display	LED red, 7 segments, height: 13 mm, 5 digits, 2 LED for switching outputs (alarm relays)
Keypad	4 keys: Enter, Back, Up, Down
Sensor input	1 x analogue input for sensors with 0...20 mA or 0/4...20 mA signal. Connectable in 2-/3- or 4-wire-technologie possible with 24 VDC supply
Burden analogue input	100 Ohm
Accuracy analogue input	max. $\leq \pm 20 \mu\text{A}$, typical $10 \mu\text{A}$
Sensor supply	24 VDC with Polyfuse max. 100 mA
Voltage supply	230 V, 50/60 Hz
Outputs	2 x relays output, changer, 250 VAC, max. 3 A
Operation temperature	-10 °C...+60 °C (storage temperature: -20 °C...+80°C)
Alarm thresholds	freeley adjustable
Hysteresis	2 °Ctd

8. Order information

<i>Description</i>	<i>Order no.</i>
DS 52 - LED display in wall housing (118 x 92 x 133 mm), Supply: 230 V. Analogue sensor input for sensors with 4...20 mA or 0...20 mA signals. 2 alarm relays (change-over contact 250 VAC, max. 3 A), alarm values freely adjustable	0500 0008
<i>Options</i>	
Option for DS 52 LED display: Supply 24 VDC instead of 230 VAC, 50/60 Hz	Z500 0001
Option for DS 52 LED display: Supply 110 VAC instead of 230 VAC, 50/60 Hz	Z500 0002

Notes

Contact

- **Advice**
- **Sale**
- **Service**

Sales office North Germany

CS Instruments GmbH
Am OXer 28c
24955 Harrislee

Phone +49 (0) 461 – 700 2025
Fax +49 (0) 461 – 700 2026

E-Mail info@cs-instruments.com
www.cs-instruments.com

Sales office South Germany

CS Instruments GmbH
Zindelsteiner Straße 15
78052 VS-Tannheim

Phone +49 (0) 7705 - 97899-0
Fax +49 (0) 7705 - 97899-20

E-Mail info@cs-instruments.com
www.cs-instruments.com